

# Studio 4

**Opcode Systems, Inc.  
365 East Middlefield Road  
Mountain View, CA 94043  
(650) 429-2400**

**<http://www.opcode.com>**

**Opcode Part Number: 110-0222-01**

Copyright ©1995 Opcode Systems, Inc. All rights reserved. This document may not, in whole or part, be copied, photocopied, reproduced, translated or converted to any electronic or machine readable form without prior consent of Opcode Systems, Inc.

## LIMITED WARRANTY

Opcode Systems, Inc. warrants the Studio 4 against defects in materials and workmanship for a period of one (1) year from the date of original retail purchase.

If you discover a defect, first write or call Opcode Systems, Inc. at (415) 856-3333 to obtain a Return Merchandise Authorization Number (no service will be performed on any product returned without prior authorization). If the product needs to be returned to Opcode, please attach your name, address, telephone number, a description of the problem, and a copy of the dated bill of sale as proof of purchase. Write the Return Merchandise Authorization (RMA) Number clearly on the outside of the package and all correspondence. Upon receiving the returned product, Opcode Systems, Inc. will then, at its option, repair, replace, or refund the purchase price of the product.

This warranty applies only to the Studio 4; Opcode software is warranted separately.

This warranty does not apply if the product has been damaged by accident, abuse, misuse, or misapplication, or has been modified without the written permission of Opcode Systems, Inc.

All implied warranties, including implied warranties of merchantability and fitness for a particular purpose, are limited in duration to one (1) year from the original date of retail purchase of this product. The warranty and remedies set forth above are exclusive and in lieu of all others, oral or written, express or implied.

Opcode Systems, Inc. is not responsible for special, incidental, or consequential damages resulting from any breach of warranty, or under any legal theory, including lost profits, downtime, good-will, damage to or replacement of equipment and property.

Some states do not allow the exclusion or limitation of implied warranties or liability for incidental or consequential damages, so the above limitation or exclusion may not apply to you. This warranty gives you specific legal rights, and you may also have other rights which vary from state to state.

Except to the extent prohibited by law, all implied warranties made by Opcode Systems, Inc. in connection with this manual and software are limited in duration to ninety (90) days from the date of original purchase, and no warranties, whether express or implied, shall apply to this product after said period.

Opcode Systems, Inc. makes no warranty or representation, either express or implied, with respect to the software described in this manual. This software is sold "as is". The purchaser assumes the entire risk as to its quality and performance. Under no circumstances shall Opcode Systems, Inc. be liable for any loss or damage, direct, consequential, or incidental, arising out of the use or inability to use this product.

Some states do not allow limitations on how long an implied warranty lasts or the exclusion or limitation of incidental or consequential damages, so the above limitations or exclusions may not apply to you.

## **COPYRIGHT**

This software and manual are copyrighted ©1995 by Opcode Systems, Inc. with all rights reserved. The software or manual may not be copied, in whole or part, without the express written consent of Opcode Systems, Inc. except for the original purchaser to make backup copies. Unauthorized duplication is prohibited.

This software is protected by both United States Copyright Law and International Treaty provisions. Opcode Systems, Inc. grants the user this license, and use confirms agreement. The Studio 4 and OMS software may be used with the Studio 4 by any number of users, and may be used on more than one computer at a time. If you have any problems with the software or hardware, please consult the user's guide first. Consult the dealer from which you purchased the Studio 4, as they are your best local source of assistance.

If you still have a problem, call Opcode Systems, Inc. Technical Support Line at (415) 856-3331. See the Studio 4 manual for details.

## **WARNING**

**NOTE:** This equipment has been type tested and found to comply with the limits for a Class B digital device, pursuant to Part 15 of the FCC Rules. These limits are designed to provide reasonable protection against harmful interference in residential installations. This equipment uses, and can radiate radio frequency energy, and if not installed and used in accordance with the instructions, may cause harmful interference to radio communications. However, there is no guarantee that interference will not occur in a particular installation.

If this equipment does cause interference to radio or television equipment reception, which can be determined by turning the equipment off and on, the user is encouraged to try to correct the interference by one or more of the following measures:

- Reorient or relocate the receiving antenna
- Move the equipment away from the receiver
- Plug the equipment into an outlet on a circuit different from that to which the receiver is powered.

If necessary, the user should consult the dealer or an experienced radio/television technician for additional suggestions.

*CAUTION: Only equipment certified to comply with Class B (computer input/output devices, terminals, printers, etc.) should be attached to this equipment, and must have shielded interface cables.*

Finally, any changes or modifications to the equipment by the user not expressly approved by the grantee or manufacturer could void the users authority to operate such equipment.

## **ACKNOWLEDGEMENTS**

Studio 4 manual written by Gregory A. Simpson and Jon Drukman.

OMS, OMS Setup, Studio Patches Editor, and Studio 4 Driver by Doug Wyatt.



---

# TABLE OF CONTENTS

## PART 1: Overview and Installation 1

<b>CHAPTER 1:</b>	<b>Getting Started</b>	<b>3</b>
	Overview of the Studio 4.....	3
	How to Read this Manual .....	3
	The Studio 4 Package .....	4
	Registering Your Studio 4 .....	4
	Timecode Basics .....	5
<b>CHAPTER 2:</b>	<b>Panel Descriptions</b>	<b>7</b>
	The Studio 4 Front Panel.....	7
	The Studio 4 Rear Panel .....	8
	About the Interface Cables.....	10
<b>CHAPTER 3:</b>	<b>Hardware Installation</b>	<b>11</b>
	Power Connection .....	11
	Computer Connections—One Studio 4.....	11
	Computer Connections—Networking .....	13
	SMPTE Connections.....	16
	MIDI Connections.....	17
<b>CHAPTER 4:</b>	<b>Software Installation and Setup</b>	<b>19</b>
	Installing OMS and the Studio 4 Software.....	19
	Launching the OMS Setup Application.....	20
	Studio 4 Icons in a Studio Setup Document .....	22
	Renaming Studio 4's.....	24
	Other Icons in a Studio Setup Document .....	25

## **PART 2: Using The Studio 4 27**

<b>CHAPTER 5:</b>	<b>Introduction</b>	<b>29</b>
	Using the Studio 4 with OMS-Compatible Applications.....	29
	Using the Studio 4 with Non-OMS Applications.....	30
	Studio 4<->Macintosh Communication Speed .....	30
	The Studio 4 Menu.....	31
<b>CHAPTER 6:</b>	<b>Network Routing Window</b>	<b>33</b>
	When To Use The Network Routing Window .....	33
	Window Overview .....	33
	Setting the MIDI Inputs.....	35
	Setting the MIDI Outputs.....	36
<b>CHAPTER 7:</b>	<b>Routing, Channelizing and Muting Window</b>	<b>39</b>
	When to use the Routing, Channelizing and Muting Window .....	39
	Window Overview .....	40
	MIDI Muting .....	42
	MIDI Channelizing .....	44
	MIDI Routing.....	45
	Timecode Routing.....	48
	MIDI Beat Clock Routing.....	49
	The Clear and Help Buttons.....	52
<b>CHAPTER 8:</b>	<b>Saving and Opening Studio 4 State Documents</b>	<b>53</b>
	Saving a Studio 4 State Document.....	53
	Opening a Studio 4 State Document .....	54
	Establishing a "Do Nothing" State .....	54
<b>CHAPTER 9:</b>	<b>SMPTE Reader Window</b>	<b>57</b>
	Using the SMPTE Reader Window.....	57
	Using with Multiple Studio 4's.....	59

<b>CHAPTER 10:</b>	<b>Stripe SMPTE Window</b>	<b>61</b>
	Setting and Using Start and Stop Times .....	61
	Setting and Using SMPTE Frame Rates.....	62
	Setting and Using the MIDI Format .....	62
	Guide to Setting SMPTE Levels.....	63
	Jam Sync .....	63
	Start JamStripe™ Button .....	64
	User Bits .....	64
	Using with Multiple Studio 4's.....	64
	SMPTE Tutorial .....	65

## **PART 3: Appendices 69**

<b>APPENDIX A:</b>	<b>Troubleshooting</b>	<b>71</b>
	Communication Problems.....	71
	Peripheral Problems .....	71
	Sync Problems.....	71
	MIDI Problems .....	73
	Miscellaneous Problems .....	74
<b>APPENDIX B:</b>	<b>Networking a Studio 4 with a Standard MIDI Interface</b>	<b>75</b>
	Computer and MIDI Connections.....	75
	Software Setup.....	76
	Using the Network.....	76
	Networking a Studio 4 and a Studio 3.....	77
<b>APPENDIX C:</b>	<b>Specifications</b>	<b>79</b>
	General.....	79
	Connectors.....	79
	Switches .....	80

---

**Table of Contents**

---



# **PART 1: Overview and Installation**



---

# CHAPTER 1: Getting Started

---

## OVERVIEW OF THE STUDIO 4

Opcode's Studio 4 is a multi-port Macintosh MIDI interface with a built-in SMPTE timecode generator and SMPTE-to-MIDI timecode converter.

MIDI features of the Studio 4 include:

- Eight independently addressable MIDI inputs and outputs—this allows access to 128 separate MIDI channels with programs that support either OMS or Mark of the Unicorn's MIDI Time Piece™.
- Networking—connect up to three additional Studio 4's for 512 separate MIDI channels. The MIDI Time Piece and Studio 4 can be part of the same network.
- Built-in MIDI routing, channelizing and muting.
- OMS patch compatibility—OMS patches processed by the Macintosh may be used with the Studio 4. OMS patches allow MIDI data to be split, transposed, modified, and mapped in many useful ways.
- Standard (1MHz) and Fast communication speeds.
- A MIDI activity indicator for each MIDI port.

- Front panel thru switches—these let you use external peripherals (such as printers or modems) without changing cables.

Timecode functions of the Studio 4 include:

- SMPTE Time Code generation (five frame rates).
- SMPTE-to-MIDI Time Code conversion.
- SMPTE-to-Direct Time Lock conversion (both DTL and DTLe).
- Jam Syncing (rewrites fresh SMPTE when locked).
- Flywheeling (remains locked despite dropouts or other short SMPTE errors).

The Studio 4 uses the Opcode MIDI System (OMS) and the Studio 4 OMS driver software to control all mapping, channelizing, routing and timecode functions.

---

## HOW TO READ THIS MANUAL

This manual does not attempt to teach fully the fundamentals of MIDI or SMPTE operation. A brief timecode overview is presented at the end of this chapter, but if

you're new to either of these standards, you should read magazines specializing in music technology, or purchase introductory MIDI and SMPTE books from your local bookstore or music dealer.

Also, you should be familiar with basic Macintosh operations. If you're not, please read the Macintosh manual before using the Studio 4.

This manual discusses how to connect, set up and use the Studio 4—it describes Studio 4 operations at the time of its printing. However, updates and changes may occur. Always look for hardware and software change information in the Read Me folder on your master program disk.

The Studio 4 uses the Opcode MIDI System (OMS) and the Studio 4 OMS driver software to control all mapping, channelizing, routing and timecode functions. If you're already familiar with OMS, you can read this manual straight through.

**NOTE:** *If you have never used OMS, read the first three chapters in this manual, then read the OMS manual before installing OMS and reading Chapter 4. Pay particular attention to the OMS manual's discussions of installation, defining devices in your studio and creating a current OMS Studio Setup document.*

This manual is divided into three parts:

- **Part 1: Overview and Installation** (Chapters 1-4)—This part discusses the Studio 4's front and rear panels and will help you to integrate the unit into your studio. It concludes with a

chapter describing software installation and setup.

- **Part 2: Using The Studio 4** (Chapters 5-10)—This part explains how to set the Studio 4 internal state and use its SMPTE features.
- **Part 3: Appendices**  
This part includes a troubleshooting section, details on networking the Studio 4 with a standard MIDI interface, and the Studio 4 specifications.

---

## THE STUDIO 4 PACKAGE

Your Studio 4 package contains the Studio 4, an AC adapter, two 12' serial cables, 4 rubber feet, rack-mount screws, OMS and Studio 4 software, an OMS manual, this Studio 4 manual and a registration card.

---

## REGISTERING YOUR STUDIO 4

Be sure to send Opcode your registration card. If we don't receive it, you won't be eligible for free technical support and various other services and products.

**IMPORTANT:** *Please write down your Studio 4 serial number here. The serial number is on the back of the Studio 4.*

S/N \_\_\_\_\_

Purchase Date \_\_\_\_\_

Once we receive your registration card, you're entitled to free technical support and information about upgrades, updates,

and new products. Also, you'll receive Opcode's periodic newsletter, which contains advanced tips, troubleshooting techniques and more.

Opcode technical support hours (Pacific Time) are 9:00am to noon and 2:00 to 5:00pm Monday through Friday.

Call (650) 429-2349 for technical support, but *please* try to find the answer in this manual first.

**NOTE:** *Technical support hours are subject to change.*

## TIMECODE BASICS

The operational portions of this manual assume you're familiar with SMPTE Time Code, MIDI Time Code, and Direct Time Lock. If you're not, you should read this section to develop a basic understanding of synchronization and the various timecode formats. Consult music technology magazines or introductory books if you need more information about any of these topics.

### SMPTE Time Code

SMPTE Time Code is an international timecode standard created by the Society of Motion Picture & Television Engineers. It specifies a format for recording digital timing information onto magnetic tape; this timing information is divided into hours, minutes, seconds and frames. By using SMPTE Time Code (often referred to simply as "SMPTE"), you can

synchronize the playback of separate audio decks, video decks and computers.

Using SMPTE requires two separate actions:

- Generating the SMPTE Time Code and recording it onto tape (a process often referred to as "striping").
- Reading the SMPTE Time Code off the tape and using it as a master timing source for synchronizing playback of other tape machines and computers.

There are two types of SMPTE Time Code: Longitudinal Time Code (LTC), and Vertical Interval Time Code (VITC). LTC is recorded on tape tracks that run linearly across the length of the tape. This format is recorded on audio tape or on the audio track of a video tape. VITC is recorded within the video portion of a video tape.

Since different video systems run at different speeds (or "frame rates"), the SMPTE format also specifies a number of different rates.

The Studio 4 will both generate and read SMPTE Time Code in the LTC format. If you have a tape striped with VITC, you'll need to use either a VITC-to-LTC converter or a VITC-to-MTC converter such as Opcode's Studio AV.

The Studio 4 supports five SMPTE frame rates. These rates are:

- 24 Frames/second—Film frame rate.
- 25 Frames/second—EBU (European) television frame rate.

- 29.97 Drop Frame—NTSC (North American) color television frame rate. This format runs at 30 Frames/second, but has the first two frames dropped every minute, except at minutes 0, 10, 20, 30, 40 and 50.
- 29.97 Frames/second (Non-Drop)—Used to sync to NTSC color television without dropping frames. SMPTE time does not match real-time, but playback pitch is unaffected.
- 30 Frames/second (Non-Drop)—Original NTSC black and white television standard. Often used in audio-only situations since there are no dropped frames and the SMPTE time is equal to real time.

Enhanced Direct Time Lock (DTLe), which provides synchronization accuracy equal to MIDI Time Code.

The Studio 4 will convert SMPTE time-code (recorded at one of the five supported frame rates) to either MIDI Time Code or one of the Direct Time Lock formats.

## **MIDI Time Code and Direct Time Lock**

MIDI computer software cannot read SMPTE Time Code directly off a tape, so the code must be converted into a format that the computer can understand. This format is called MIDI Time Code (MTC). The converter then sends MTC (which retains SMPTE's hour/minute/second/frame timing information) to the computer to control the playback of MIDI sequencers. You use MIDI Time Code to synchronize your computer sequence to a master SMPTE timing source.

Direct Time Lock (DTL) and Enhanced Direct Time Lock (DTLe) are alternate MIDI synchronization formats developed by Mark of the Unicorn for their Performer sequencer. Very old versions of Performer require DTL to sync to tape. Newer versions of Performer use

---

## CHAPTER 2: Panel Descriptions

### THE STUDIO 4 FRONT PANEL



Figure 2.1: Studio 4 Front Panel

From left to right, the front panel ports, LED's and buttons are as follows:

#### MIDI Ports 7/15 and 8/16

These two pairs of MIDI ports are on the front panel to facilitate quick, temporary connection of synthesizers, controllers or other MIDI devices. MIDI ports are discussed in detail in “The Studio 4 Rear Panel” section later in this chapter.

Front panel MIDI output ports 7/15 and 8/16 are duplicates of MIDI output ports 7/15 and 8/16 found on the rear panel. If you connect a device to both a front panel MIDI output and its corresponding rear panel output, MIDI data will be sent to both devices.

Front panel MIDI input ports 7/15 and 8/16 are in addition to the 6 MIDI inputs found on the rear panel. MIDI input ports 7/15 and 8/16 are not duplicated on the rear panel.

If the 1-8/9-16 switch is in the 1-8 position, these two ports are numbered 7 and 8. If the 1-8/9-16 switch is in the 9-16 position, the ports are numbered 15 and 16.

#### MIDI In LED's

These eight red Light Emitting Diodes (LED's) indicate MIDI data is arriving at one or more of the Studio 4's eight MIDI input ports.

#### MIDI Out LED's

This row of green Light Emitting Diodes (LED's) indicates MIDI data is leaving one or more of the Studio 4's eight MIDI output ports.

#### 1MHz/Fast Switch

Use this switch to select a communication speed. 1MHz is the standard MIDI interface speed required by most MIDI software. Fast speed increases MIDI throughput, thereby increasing the number of simultaneous MIDI channels. Check your MIDI application manuals to see if they support Fast mode. Opcode products that support Fast mode include Vision, Studio Vision and EZ Vision.

**NOTE:** *The Studio 4 driver software must match the speed selected by the 1MHz/Fast switch. Configure the Studio 4 driver software as discussed in the “Studio 4 >Macintosh Communication Speed” section in Chapter 5.*

### 1-8/9-16 Switch

Select the 1-8 position (switch in) if the Studio 4 is the first or only Studio 4 in a network. This assigns port numbers 1 through 8 to the Studio 4's eight MIDI ports.

Select the 9-16 position (switch out) if the Studio 4 is the second in a network. This assigns port numbers 9 through 16 to the Studio 4's eight MIDI ports. Network connections are discussed in Chapter 3.

**NOTE:** *If you are using just one Studio 4, set this switch to the 1-8 position.*

### Thru Switches (A & B)

These switches provide convenient access to printers, modems or other peripherals.

When a Thru switch is in the MIDI position, the Studio 4 is in MIDI mode—transmitting MIDI data between your Macintosh and various studio devices.

When a Thru switch is in the THRU position, data from the Macintosh (as received on either the “A” or “B” input ports) is passed through the Studio 4 to the “A Thru” or “B Thru” ports on the rear panel. Set a Thru switch to the THRU

position when your Macintosh needs to communicate with an external peripheral (such as a printer or modem).

### SMPTE/Power Indicator Light

This LED blinks when there is any SMPTE activity. When no timecode is sent or received, the LED is lit as a power indicator.

### Power Switch

When pushed in, the power is ON. When out, the power is OFF. The SMPTE/Power LED should light when the switch is in the ON position if the power supply is connected to the Studio 4 and plugged in.

---

## THE STUDIO 4 REAR PANEL

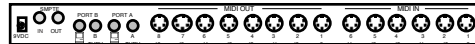

Figure 2.2: Studio 4 Rear Panel

From left to right, the rear panel connectors are as follows:

### Power Connector

Plug the power supply into this jack. Use only a 9VDC 1.5A center-positive power supply. The power supply is included with the Studio 4.



## **SMPTE IN Jack**

This jack receives SMPTE timecode from a tape deck or other SMPTE source. The Studio 4 converts the SMPTE input into the MIDI format specified by the Stripe SMPTE window (see Chapter 10).

## **SMPTE OUT Jack**

This jack outputs SMPTE timecode generated (or regenerated) by the Studio 4. This jack is normally connected to the line input of a tape deck. You may set the SMPTE output level in the Stripe SMPTE window (See Chapter 10).

## **Computer Ports and Thru Ports**

The Studio 4 does not implement the traditional Macintosh MIDI interface concept of a “Printer port” and a “Modem port”. Older interfaces have a limit of 32 addressable MIDI channels; 16 on the Printer port and 16 on the Modem port. Each Studio 4, however, can address up to 128 separate MIDI channels spread across its two serial inputs. These input ports are labeled “A” and “B”. The inputs (with the little Macintosh icons) connect to the Macintosh using standard 8-pin mini-DIN cables (supplied by Opcode with the Studio 4).

You may connect the Studio 4 “A” port to either the Macintosh Modem port or Printer port. You may connect the Studio 4 “B” port to the Modem port, the Printer port or to another Studio 4 to form a network. You can also connect two Macintosh computers to one or two Studio 4’s

(See “Computer Connections” in Chapter 3).

You cannot use the “A” port for networking. As a matter of convention, you may wish to connect “A” to the Modem port, leaving the “B” port free for connecting the Macintosh’s Printer port, another Macintosh or another Studio 4.

Attach external peripherals (such as a printer or modem) to the “A THRU” and/or “B THRU” ports on the Studio 4. You can use these peripherals without disconnecting the Studio 4 from the Macintosh. Simply use the corresponding front panel Thru switch to route data arriving at one of the Studio 4 computer ports to its corresponding THRU port (see “Thru Switches” earlier in this chapter, and “Computer Connections” in Chapter 3).

## **MIDI OUT Connectors**

Connect these eight ports to the MIDI IN ports of your MIDI devices. Each port has dual numbers that correspond to the position of the 1-8/9-16 switch on the front panel.

MIDI output ports 7/15 and 8/16 are duplicated on the front panel. If you connect devices to both a front panel MIDI output and its corresponding rear panel output, MIDI data is sent to both devices.

## **MIDI IN Connectors**

Connect these six ports to the MIDI OUT ports of your MIDI devices. Each port has dual numbers that correspond to the posi-

tion of the 1-8/9-16 switch on the front panel. Two additional inputs are on the front panel.

---

## **ABOUT THE INTERFACE CABLES**

The Studio 4 comes with standard 8-pin mini-DIN cables. If you are using cables other than the ones supplied with the Studio 4, please ensure that they are 8-pin mini-DIN.

You should use only high quality shielded MIDI and audio cables when operating your Studio 4 or any other professional audio equipment.

## CHAPTER 3: Hardware Installation

Use the rackmount screws (provided) to mount the Studio 4 in a standard 19" equipment rack as shown in Figure 3.1.

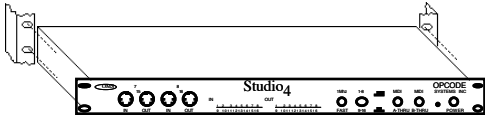

Figure 3.1: Rack Installation

If you do not wish to rack mount the Studio 4, you may sit it on a steady surface. Attach the four rubber feet (provided in this package) to the bottom of the unit to prevent it from sliding.

### POWER CONNECTION

Place the tip of the power supply cord into the power jack on the far left side of the rear panel, then plug the power supply into a standard 120VAC, 60Hz electrical outlet. Use only a 9VDC, 1.5A, center positive AC power adaptor with the Studio 4.

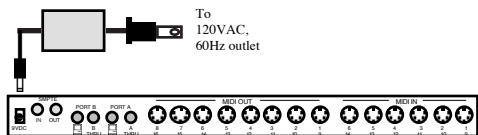

Figure 3.2: Power Supply Connection

### COMPUTER CONNECTIONS— ONE STUDIO 4

You may connect the Studio 4 to either the Macintosh's Modem port, Printer port, or to both. Connect the supplied serial cables between the Studio 4 and the Macintosh as discussed in the following sections.

#### Single Port Connection

Single port connections are useful if you frequently use a Macintosh serial port for non-MIDI purposes (such as printing) while running MIDI applications. You can use the spare Macintosh serial port without using the Studio 4's front panel MIDI/THRU switch.

You may connect either the Studio 4's "A" port or "B" port to either the Macintosh Modem or Printer port. The "B" port, unlike the "A" port, can also be used to connect an additional MIDI Interface. For this reason (and as a matter of convention) you may wish to connect "A" to the Mac's Modem port, leaving the "B" port free for later connection to either the Mac's Printer port (discussed in the "Dual Port Connection" section) or to another interface (discussed in the "Computer Connections—Networking" section).

Figure 3.3 illustrates a common single port connection.

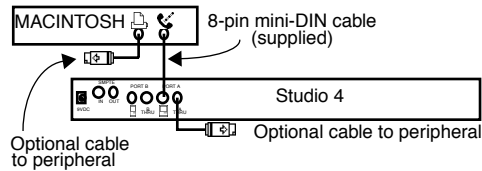

**Figure 3.3: Single (Modem) Port Connection**

Figure 3.3 uses only the Macintosh Modem port for communicating with the Studio 4. One external peripheral (such as a printer) can be connected directly to the Macintosh Printer port. You can connect an additional external peripheral (such as a modem) to the “A THRU” jack on the Studio 4 and switch it in or out from the front panel.

### Dual Port Connection

Use a dual port connection if you need increased MIDI “throughput” (for example, your MIDI data is densely packed with notes, continuous controls, System Exclusive messages and MIDI Time Code). It’s a good idea to always use a dual port connection when you’re synchronizing MIDI playback with SMPTE timecode.

You may connect the Studio 4’s “A” port to either Macintosh serial port. Similarly, you may connect the “B” port to either the Modem or Printer port.

Figure 3.4 illustrates a common dual port connection. Connect both Macintosh serial ports to the Studio 4, and attach any

external peripherals to the Studio 4 THRU jacks. You can switch between the Studio 4 and the external peripherals by using the corresponding THRU switch on the front panel.

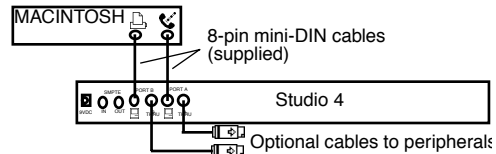
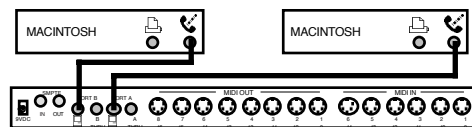

**Figure 3.4: Dual Port Connection**

**NOTE:** *In a two cable system, such as shown in Figure 3.4, use the Network Routing window to distribute data between ports (see Chapter 6).*

### Connecting Two Macintosh Computers

Two Macintosh computers may share one Studio 4 by connecting one Macintosh to the Studio 4 “A” port and connecting the other Macintosh to the Studio 4 “B” port.



**Figure 3.5: Two Macs Sharing One Studio 4**

You can also connect two Studio 4’s to two Macintosh computers as shown in Figure 3.6. This is an example of a Studio 4 network. Networking connections are discussed in the next section.

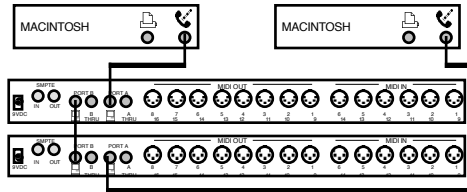

Figure 3.6: Two Macs Sharing Two Studio 4's

If you connect two computers to a Studio 4, you must check the **Multiple Computers** option in the **Studio 4** menu. Do not check this option if you're not using two computers to control the Studio 4.

### Multiple Macintosh Caveat

Use only one computer at a time to initiate actions that change a Studio 4's internal state—always wait at least 1 second before initiating any state-changing actions from a different computer.

Actions that cause the Studio 4 to change state include:

- Clicking anywhere in either the Network Routing window or the Routing, Channelizing and Muting window.
- Switching, opening or quitting applications.
- Performing Galaxy patch transfers.
- Making different windows active in OMS Setup and the Studio Patches Editor.
- Using the Enable Inputs dialog in Vision.

If you use different computers to change the Studio 4's internal state too quickly,

the enabling and/or routing of Studio 4 inputs to the Macintosh computers may be incorrect. If you suspect trouble, choose **OMS MIDI Setup** from within any OMS application and click **OK**.

## COMPUTER CONNECTIONS—NETWORKING

A network is defined as the connection of one or two Studio 4's to a single Macintosh serial port. The Macintosh has two serial ports, so it can support two networks. Since each network can contain either one or two Studio 4's, you can connect up to four Studio 4's to a single Macintosh for a maximum total of 512 MIDI channels.

**NOTE:** *When networking two Studio 4's, always connect their "B" ports together.*

### Connecting Two Studio 4's to a Macintosh

There are many possible ways to connect two Studio 4's to a single Macintosh. You can connect them as one network on a single port, as two separate networks, or as a 2-cable network. With two Studio 4's, you can access up to 256 independent MIDI channels.

#### One Network/1-Cable

The first option is to connect both Studio 4's in a single network as shown in Figure 3.7. Set each Studio 4's front panel 1-8/9-16 switch as indicated. You may connect the network to either Macintosh

serial port. The advantage of this connection is that you retain a free Macintosh serial port. The disadvantage is that all MIDI and timecode communications occur over a single Macintosh port—you could get data overloads if you have a very dense MIDI data stream and are syncing to SMPTE timecode.

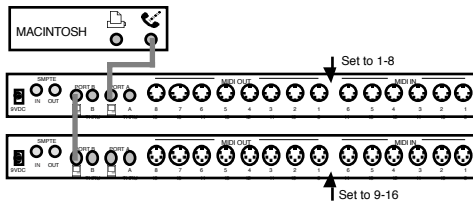

**Figure 3.7: One Network of Two Studio 4's**

### Two Networks

The second networking option involves placing one Studio 4 on each Macintosh serial port as shown in Figure 3.8. Set each Studio 4's front panel 1-8/9-16 switch as indicated. With this connection, you can balance the MIDI data stream between the two Macintosh serial ports using the Network Routing window (discussed in Chapter 6). You cannot, however, use internal routings to send MIDI data from one box to another (as discussed in Chapter 7).

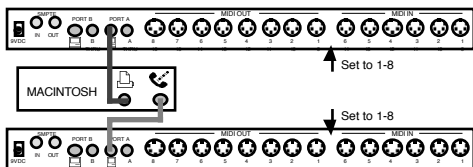
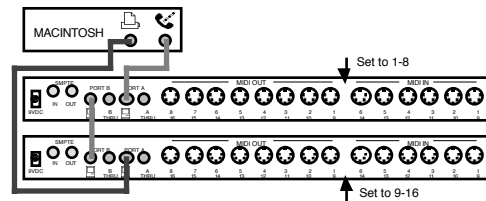

**Figure 3.8: Two Networks of One Studio 4 Each**

### One Network/2-Cables

The final option is to use a single 2-cable network. This is similar to the one network/1-cable configuration, except you connect a second cable between the last Studio 4's "A" port and the unused Macintosh serial port as shown in Figure 3.9. Set each Studio 4's front panel 1-8/9-16 switch as indicated.

This configuration provides optimum flexibility. You can balance the MIDI data stream (unlike the one network/1-cable connection) and you can use the Studio 4's internal routing to send MIDI data between interfaces (unlike the two network connection). Use the Studio 4's front panel THRU switches to access external peripherals.



**Figure 3.9: One 2-Cable Network of Two Studio 4's**

### Connecting Three Studio 4's to a Macintosh

You must use two networks if you wish to connect three Studio 4's to a Macintosh. One network contains two Studio 4's; the other network contains one. Set each Studio 4's front panel 1-8/9-16 switch as indicated. Figure 3.10 shows a typical connection involving three Studio 4's—with

this connection, you can access up to 384 independent MIDI channels.

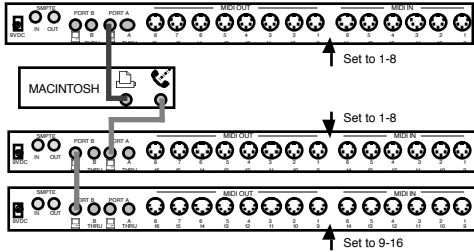

Figure 3.10: Three Studio 4's in Two Networks

### Connecting Four Studio 4's to a Macintosh

You can connect a maximum of four Studio 4's to a Macintosh. This connection uses two networks of two Studio 4's as shown in Figure 3.11. Set each Studio 4's front panel 1-8/9-16 switch as indicated. You can access up to 512 independent MIDI channels when you use four Studio 4's.

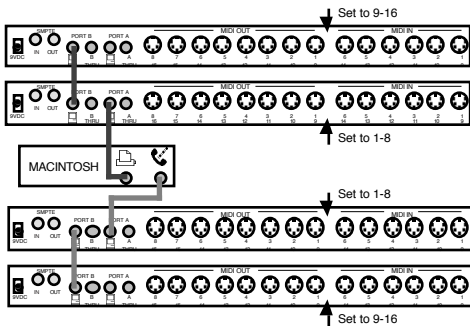

Figure 3.11: Four Studio 4's in Two Networks

### Networking Studio 4's and MIDI Time Pieces

You can use MIDI Time Pieces and Studio 4's together. In fact, the Studio 4 and MIDI Time Piece are completely interchangeable in a 2-unit network. When networked, OMS views the MIDI Time Piece as another Studio 4 and uses the Studio 4 OMS driver instead of the MTP driver. Figure 3.12 illustrates an example of a MIDI Time Piece in a Studio 4 network.

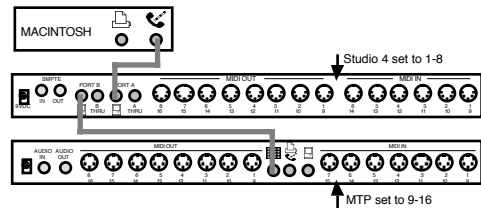

Figure 3.12: MTP in a Studio 4 Network

**NOTE:** The MIDI Time Piece Network port is equivalent to the Studio 4 "B" port.

Whenever you network a MIDI Time Piece with a Studio 4, the MTP always appears to OMS as a Studio 4. The MIDI Time Piece OMS driver is used only when the MIDI Time Piece is alone on a single port or when it's networked with another MIDI Time Piece.

**NOTE:** The Studio 4 uses a more efficient communication protocol than the MIDI Time Piece, so when networking these two interfaces, it is best to have the Studio 4 connected to the Macintosh.

## Networking Studio 4's and Standard MIDI Interfaces

You may network a Studio 4 with a standard MIDI interface. If you own an old standard MIDI interface and have more than 8 MIDI devices, the standard MIDI interface will provide a few additional MIDI ports. Figure 3.13 shows an example of a Studio 4 networked with a standard MIDI interface.

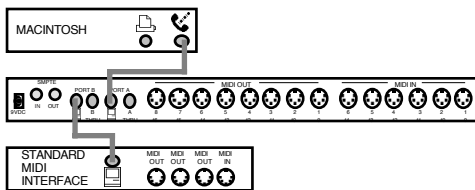

Figure 3.13: Standard MIDI Interface in a Studio 4 Network

Because your Studio 4 must be used at 1MHz when networked with a standard MIDI interface and because MIDI routing is not as flexible as with a network of two Studio 4's, you should consider this arrangement only as a temporary “band aid”. If you often need to access more than 8 MIDI devices, you should seriously consider purchasing an additional Studio 4.

**NOTE:** You cannot network a self-powered standard interface (such as a MIDI Translator) with the Studio 4.

If you use a dual port standard MIDI interface, you can connect its second serial port to the free Macintosh serial port to access even more MIDI ports.

If your dual port standard MIDI interface is a Studio 3, Opcode strongly recommends that you connect the Studio 3 modem port to the Studio 4 “B” port, and the Studio 3 printer port directly to the Macintosh (as shown in Figure 3.14). This is because the Studio 3 communicates with the Macintosh only over its printer port.

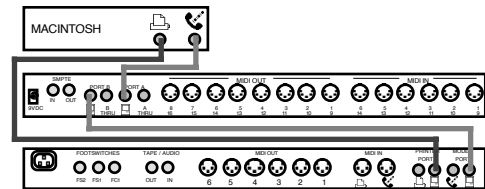

Figure 3.14: Studio 3 in a Studio 4 Network

Network connections involving a Studio 4 and a standard MIDI interface are rather atypical. If you use this type of network in your studio, you should first learn to use the Studio 4 by itself. Only after you understand the operations of the Studio 4 and OMS patches should you attempt this network. For this reason, instructions for working with these connections are discussed in Appendix B.

## SMPTE CONNECTIONS

The Studio 4 has two SMPTE jacks on its rear panel. The SMPTE IN jack is used to receive a tape sync signal. The SMPTE OUT jack sends SMPTE timecode as specified in the Stripe SMPTE window discussed in Chapter 10. If the Studio 4 is receiving SMPTE at its SMPTE IN jack, it



duplicates the timecode and sends it to the SMPTE OUT jack.

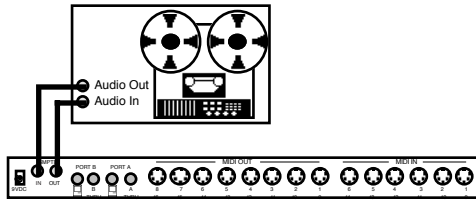

Figure 3.15: SMPTE Connections

To use the Studio 4 as a synchronization device, connect a pair of shielded audio cables between the Studio 4 and a multi-track tape deck. Connect the SMPTE OUT jack to the audio input of a tape deck for SMPTE striping (usually the last track). Connect the SMPTE IN jack of the Studio 4 to the audio output of the multi-track's SMPTE track. Connect the Studio 4 directly to the tape deck, bypassing the mixing console, equalizer, or any other signal processing equipment.

## MIDI CONNECTIONS

Connect a MIDI device's MIDI input to a MIDI OUT port on the Studio 4. Connect the like-numbered Studio 4 MIDI IN port to the device's MIDI output. Figure 3.16 shows some typical MIDI connections.

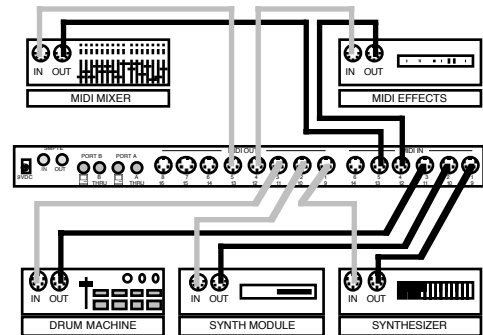

Figure 3.16: MIDI Connections

**NOTE:** *If you wish to load patches from a device into Opcode's Galaxy program, you must connect that device's MIDI In and Out ports to identically-numbered ports on the Studio 4 (as shown in Figure 3.16).*



---

# CHAPTER 4: Software Installation and Setup

---

## INSTALLING OMS AND THE STUDIO 4 SOFTWARE

**NOTE:** *If you have never used OMS, you should stop and read the OMS manual before continuing with the Studio 4 manual.*

The Studio 4 uses the OMS Setup and Studio Patches Editor applications with the Studio 4 OMS driver to control all mapping, channelizing routing and time-code functions.

Follow the installation instructions on the OMS disk to install OMS and the Studio 4 software.

### What's Installed

The Installer places all the necessary OMS and Studio 4 files onto your hard disk automatically. After running the Installer and restarting your Macintosh, you can begin to use OMS and your Studio 4.

**NOTE:** *You must install the Studio 4 OMS driver to use the Studio 4. The Studio 4 requires OMS version 1.2 or later.*

See the OMS manual to learn about the various OMS files and where they're installed.

The Studio 4 package includes some additional files that aren't part of basic OMS:

- **Studio Patches Editor**—This application adds the ability to create OMS patches. OMS patches are discussed in Part Three of this manual.
- **OMS Program Changes**—This driver allows you to change OMS patches from Macintosh applications and is installed in the OMS Folder within the System Folder. See “Sequencing Patch Changes” in Chapter 11 for more information.
- **Studio 4 OMS Driver**—This driver allows OMS to operate with your Studio 4 and is installed in the OMS Folder within the System Folder.

**CAUTION:** *Do not relocate or rename any files or folders that the Installer places in the System Folder. You may delete unnecessary files, but some files are essential for OMS operation. See the Software Definitions section of your OMS manual for more information.*

Although the Studio 4 works with non-OMS applications, all programming and setup of the Studio 4 is handled by OMS.

If you have never worked with OMS, please read the OMS manual before continuing with the Studio 4 manual.

---

## LAUNCHING THE OMS SETUP APPLICATION

By now you should have connected the Studio 4 to your Macintosh and installed the OMS software. The next step is to launch the OMS Setup application:

- ① **Turn on your Studio 4.**
- ② **Double-click the OMS Setup icon.**



If you have never used OMS, or if you haven't defined a current Studio Setup document, you will need to open and create a new Studio Setup document. Your OMS manual describes this procedure in detail, but highlights are included in the next section, “Creating a New Custom Studio Setup Document.”

If you are already an OMS user and have defined a current Studio Setup document, you will need to update your setup to work with the Studio 4. This is described in “Updating an Old Studio Setup Document”, later in this chapter.

## Creating a New Custom Studio Setup Document

- ① **Launch the OMS Setup application.**

If you do not have a current OMS Studio Setup document, you will be asked to create one when you launch the OMS Setup application.

A dialog box appears (as shown in Figure 4.1). There is a check box for each Macintosh serial port. You should check only those ports that are connected to the Studio 4 or any other MIDI interface you wish to appear in your Studio Setup document.

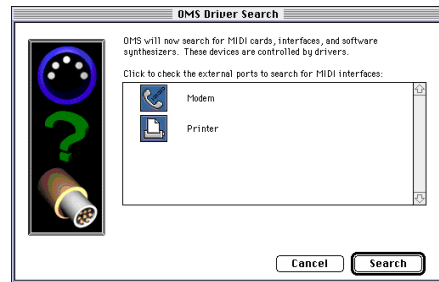

**Figure 4.1: Interfaces Dialog Box**

- ② **Click Search or hit the return key.**

The Macintosh searches the checked serial ports for MIDI interfaces. It also looks for any NuBus cards that have an OMS driver installed. When it finds all interfaces and cards, it creates a new, untitled Studio Setup document. The

Studio Setup document contains an icon for each Studio 4 and OMS driver object found.



Figure 4.2: Untitled Studio Setup Document

③ **Add MIDI devices and connect them as discussed in your OMS manual.**

Each device that you connect to the Studio 4 will have a port number in its path. You must set MIDI port numbers in the Studio Setup document to reflect the actual Studio 4 port numbers to which devices are connected.

## Updating an Old Studio Setup Document

If you already have a current Studio Setup document, but it doesn't reflect your current studio configuration (for example, you had a standard interface, but are now using the Studio 4), you'll need to update it.

① **Launch OMS Setup.**

Your current studio setup document opens.

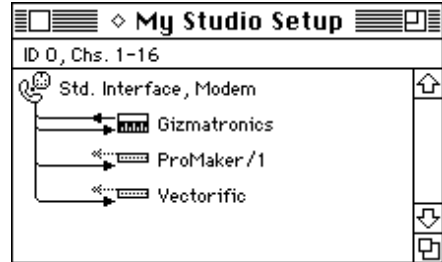

Figure 4.3: Standard Interface Studio Setup Document

② **Choose Studio>MIDI Cards & Interfaces to open the Update Setup dialog box.**

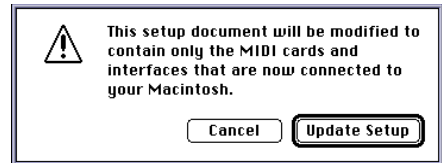
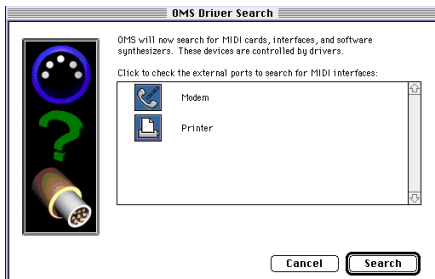

Figure 4.4: Update Setup Dialog Box

③ **Click Update Setup or hit the return key.**

A dialog box appears. There is a check box for each Macintosh serial port. You should check only those ports that are

connected to the Studio 4 or any other MIDI interface you wish to appear in your Studio Setup document.



**Figure 4.5: Interfaces Dialog Box**

- ④ **Click **Search** or hit the return key.**

Your old interface disappears from your Studio Setup document and is replaced with a Studio 4 icon. Any devices that were attached to old interfaces appear unconnected in the updated Studio Setup document.

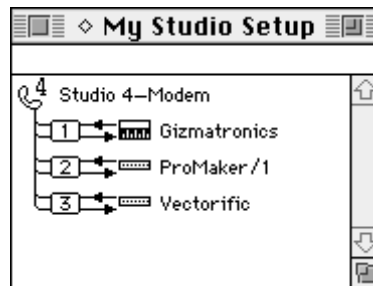

**Figure 4.6: Unconnected Setup Document**

- ⑤ **Connect the device icons to the Studio 4 icon using techniques discussed in the OMS manual.**

Each device that you connect to the Studio 4 will have a port number in its path. You must set MIDI port numbers in

the Studio Setup document to reflect the actual Studio 4 port numbers to which devices are connected.



**Figure 4.7: Updated Studio Setup Document**

- ⑥ **Save your Studio Setup document.**

## **STUDIO 4 ICONS IN A STUDIO SETUP DOCUMENT**

The Studio 4 icons that appear in your Studio Setup document depend on the number of Studio 4's and how they're connected to the Macintosh. Each Studio 4 is given its own icon and shows the name of the Macintosh serial port to which it's connected. If the words "2 cables" appear, it indicates that two connecting cables are used.

The following sections show specific examples of Macintosh-to-Studio 4 connections and the resulting Studio Setup icons.

### **One Studio 4**

If you have only one Studio 4 connected to your Macintosh when you search the

serial ports, then your Studio Setup document will contain one Studio 4 icon. Figure 4.8 shows the possible ways to connect a single Studio 4 to a Macintosh and the Studio Setup icons that result.

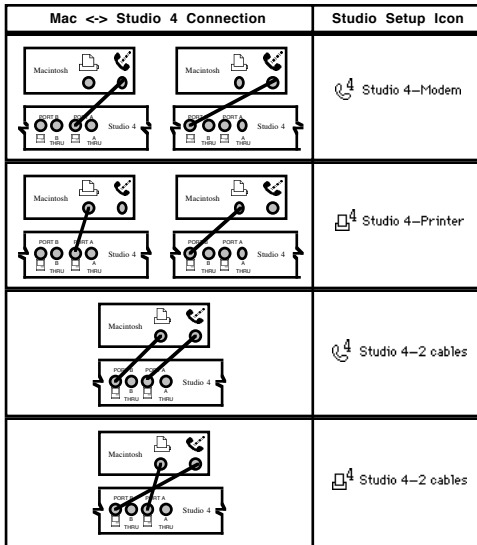

Figure 4.8: Studio Setup Icons—One Studio 4

Notice that when both serial ports are connected to a single Studio 4, there is only one icon. When a standard MIDI interface is connected to both serial ports you see two icons; one representing the Modem port and the other the Printer port. The Studio 4 appears as a single interface because you use the Network Routing window (discussed in Chapter 6) to allocate MIDI data to each of the serial ports.

## Two Studio 4's

There are numerous ways to connect two Studio 4's to a Macintosh. Some of these connections are shown in Figure 4.9 along with the resulting Studio Setup icons.

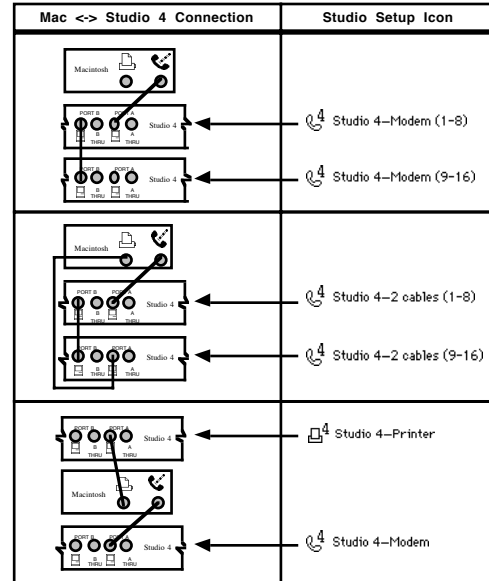
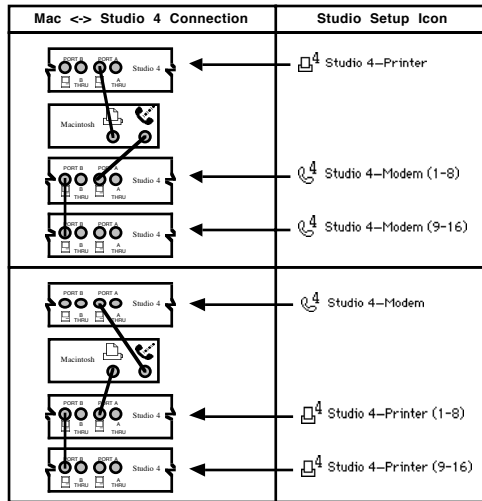

Figure 4.9: Studio Setup Icons—Two Studio 4's

The “1-8” and “9-16” next to the Studio 4 icons indicate the MIDI port numbers when there are two Studio 4's in a network (as selected by the Studio 4's front panel 1-8/9-16 switch).

### Three Studio 4's

Figure 4.10 illustrates some connections involving three Studio 4's and the resulting Studio Setup icons.



**Figure 4.10: Studio Setup Icons—Three Studio 4's**

### Four Studio 4's

If you connect four Studio 4's to a Macintosh, they will be shown in the Studio Setup document as shown in Figure 4.11.

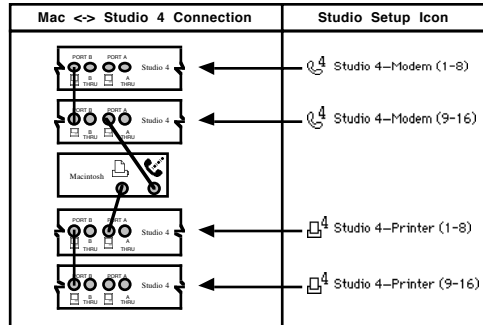

**Figure 4.11: Studio Setup Icons—Four Studio 4's**

### RENAMING STUDIO 4'S

You can rename one or more of your Studio 4's in the Studio Setup document. To do so, simply click the name to the right of the Studio 4 icon and type in a new name. The name you choose appears in place of the default Studio 4 name anywhere that the interface name appears.

In the following example, Figure 4.12 shows a Studio Setup document with the default Studio 4 name and a pop-up menu listing the Studio 4 as a selection. Figure 4.13 shows a Studio Setup document with a custom Studio 4 name and the same pop-up menu listing the Studio 4 as a selection.



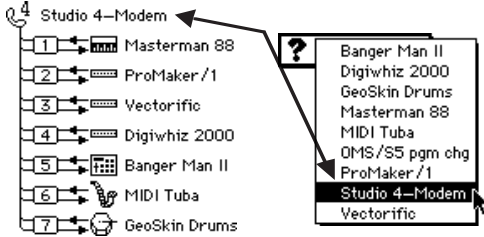

Figure 4.12: Default Studio 4 Name

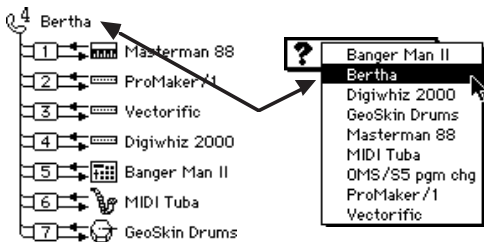

Figure 4.13: Custom Studio 4 Name

## OTHER ICONS IN A STUDIO SETUP DOCUMENT

Your Studio Setup document also displays icons for any other interfaces, NuBus cards or devices connected directly to your Macintosh.

A MIDI Time Piece always uses the Studio 4 driver when it's networked with a Studio 4. It appears in the Studio Setup document as a Studio 4 with the default name "MTP as S4". The only time a MIDI Time Piece icon appears is when the MTP is alone on its own port, or when it's networked with another MTP.

Interface icons and NuBus card icons are discussed in your OMS manual.



# **PART 2: Using The Studio 4**



---

## CHAPTER 5: Introduction

Before beginning this section, you should have read your OMS manual and created a current Studio Setup document. Studio 4 programming uses OMS and references the current Studio Setup document. If you haven't read your OMS manual or if you haven't created a Studio Setup document, do so at this time.

The Studio 4 integrates seamlessly with programs that use OMS. With programs that don't use OMS, it can emulate a MIDI Time Piece or it can be used as a standard MIDI interface.

There are three ways to control MIDI routing when you use a Studio 4:

- **With a sequencer application.** Most sequencers (such as Vision or Performer) control MIDI routing within the application. You use the sequencer to route MIDI inputs to MIDI outputs.
- **With a Studio 4 state.** A Studio 4 state reflects the settings of the Network Routing window (see Chapter 6) and the MIDI Routing, Channelizing and Muting window (see Chapter 7). You can save and recall Studio 4 states at any time. The Studio 4 always retains the latest state even when power is turned off.

- **With an OMS patch.** OMS patches allow you to design very advanced MIDI routing and processing paths using the Macintosh (not the Studio 4) to process MIDI data. OMS patches are discussed in the Studio Patches Editor manual.

---

### USING THE STUDIO 4 WITH OMS-COMPATIBLE APPLICATIONS

Unless you use the Studio 4 for strictly for live performance, you'll probably use it with sequencers, librarians and other MIDI applications. These programs require you to enable MIDI input devices within them—that is, you need to tell the application which MIDI device(s) you'll use to input MIDI data.

With OMS-compatible applications (such as Vision and Galaxy) you need only make sure the input is enabled within the application in order to route data from the device, through the Studio 4 and into the application. When you enable input devices within OMS-compatible applications, OMS tells the Studio 4 driver which inputs are enabled. The Studio 4 driver then tells each Studio 4 in your network which inputs to route to the Macintosh.

In OMS-compatible applications, if you choose the Studio 4 as a MIDI input, only timecode from the Studio 4 and MIDI beat clock from any devices connected to the Studio 4 are sent to the application—other types of MIDI data from devices attached to the Studio 4 are not sent. Select devices by name (rather than selecting the interface) if you want to use them as MIDI inputs.

For example, look at Figure 5.1.

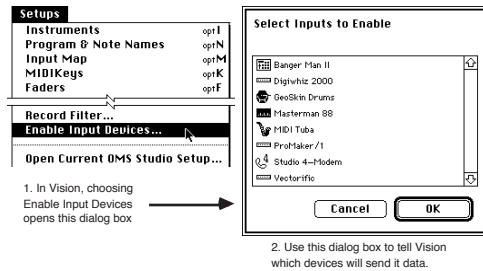

Figure 5.1: Enabling Inputs in Vision

In this example, the GeoSkin Drums, Masterman 88 and MIDI Tuba are enabled as input devices in Vision (they are highlighted). Vision “sees” MIDI data only from these devices. Data from other devices connected to the Studio 4 is not sent to Vision.

See your OMS-compatible application manuals for more information.

## USING THE STUDIO 4 WITH NON-OMS APPLICATIONS

The Studio 4 acts like a standard interface or a MIDI Time Piece when used with non-OMS applications. Use the Network Routing window’s Compatibility columns to enable MIDI inputs and outputs, and the Port columns to choose port assignments. The Network Routing window is discussed in Chapter 6.

## STUDIO 4<->MACINTOSH COMMUNICATION SPEED

For each Studio 4 that’s connected directly to a Macintosh, you must set a basic communication speed to match both the position of the Studio 4’s front panel 1MHz/Fast switch and the communication speed settings you choose in your MIDI applications. If you’re using Fast mode, you may also optimize the Studio 4-to-Macintosh communication speed for maximum MIDI throughput.

To establish communication speed, you must:

1. Open the current OMS Studio Setup document and double-click a Studio 4 <->Macintosh Communication Speed dialog box.



Figure 5.2: Double-click Studio 4 Icon

The Studio 4->Mac Communication Speed dialog box looks as shown in Figure 5.3.

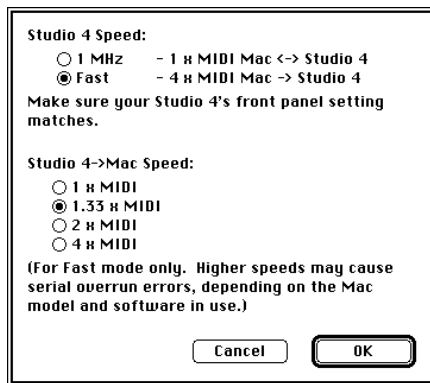

Figure 5.3: Studio 4->Mac Communication Speed Dialog Box

- ② Set a basic communication speed with the top set of radio buttons.
- ③ Set a Studio 4->Macintosh communication speed with the lower set of radio buttons.
 

These buttons allow you, when in Fast mode only, to select an optimum Studio 4->Mac communication speed.
- ④ On the Studio 4's front panel, set the 1MHz/Fast switch to match the setting in the Communication Speed dialog box.

- ⑤ Click **OK** when you're finished and perform the same operation for any other Studio 4's connected directly to the Macintosh.

## Determining the Optimum Studio 4->Mac Speed

The optimum Studio 4->Mac speed provides the fastest communication speed without overrun errors. The default is 1.33 x MIDI. Increase this speed if you would like higher throughput. Decrease it if you get overrun errors.

## THE STUDIO 4 MENU

A Studio 4 menu appears in the OMS Setup application whenever a Studio 4 driver is installed and the current Studio 4 Setup document contains one or more Studio 4's. Studio 4 menu commands are described in the indicated chapters.

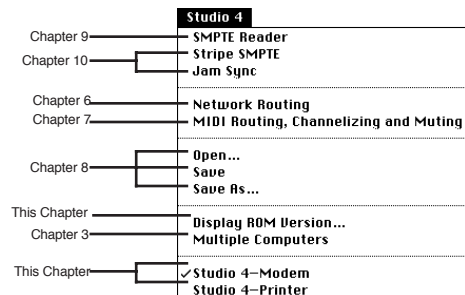

Figure 5.4: Studio 4 Menu

## Display ROM Version...

Choose this command to display the version numbers of your Studio 4 ROM. You should know your ROM version if you call Opcode Technical Support about your Studio 4.

## Choosing Between Multiple Studio 4's

Any time the current Studio Setup document contains more than one Studio 4, you'll see a listing of them at the bottom of the **Studio 4** menu.

To select (check) a Studio 4, simply pull down the menu and release the mouse over the desired Studio 4.

The SMPTE Reader and Stripe SMPTE windows work with the selected Studio 4. You must select a Studio 4 *before* opening either the SMPTE Reader or Stripe SMPTE windows. The SMPTE Reader window is discussed in Chapter 9. The Stripe SMPTE window is discussed in Chapter 10.

Choose *any* Studio 4 on a modem port to open either a Network Routing window or a Routing, Channelizing and Muting window for the modem port. Similarly, choose *any* Studio 4 on a printer port to open either a Network Routing window or a Routing, Channelizing and Muting window for the printer port. The Network Routing window is discussed in Chapter 6. The Routing, Channelizing and Muting window is discussed in Chapter 7.

## Using the Studio 4 Menu with a MIDI Time Piece

If you network a MIDI Time Piece with a Studio 4, the MTP appears as a Studio 4 in the Studio Setup document and is labeled "MTP as S4". Everything in the Studio 4 menu works with the networked MTP except **Stripe SMPTE**, **Jam Sync** and **Display ROM Version**. You can open the SMPTE Reader window for a MIDI Time Piece that's networked to a Studio 4 and it'll work except you can't change the MIDI synchronization format.



---

## CHAPTER 6: Network Routing Window

### WHEN TO USE THE NETWORK ROUTING WINDOW

You need to use the Network Routing window when:

- working with non-OMS applications.
- using both Macintosh serial ports (Printer and Modem) with one or more Studio 4's.

You will never need the Network Routing window if you use only one Macintosh serial port and you use only OMS MIDI applications.

### WINDOW OVERVIEW

Choose **Network Routing** from the **Studio 4** menu to open the Network Routing window.

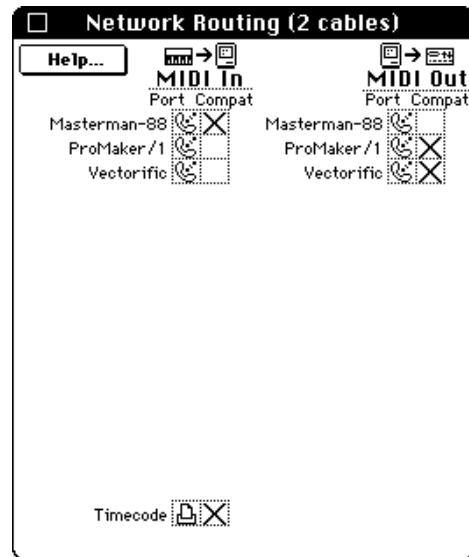
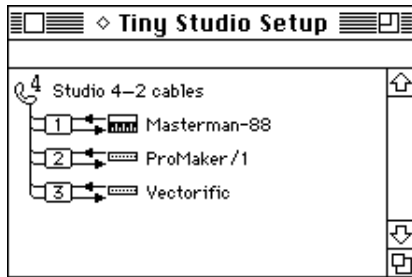

Figure 6.1: Network Routing Window

The Network Routing window displays the names of the devices entered in your current OMS Studio Setup document. Click the **Help** button to open on-line information about the Network Routing window.

The Network Routing window shown in Figure 6.1 is based on the Studio Setup document shown in Figure 6.2. Your Network Routing window will reflect your own current OMS Studio Setup document.



**Figure 6.2: Studio Setup Document**

The Network Routing window has two functions:

- When working with non-OMS applications, it controls which inputs the Studio 4 sends to the Macintosh and which devices receive output from the Macintosh.
- For any application, if you connected both Macintosh ports to one or more Studio 4's, it controls which port carries the data for each device defined in your current OMS Studio Setup document.

When you edit this window, the changes are sent immediately to the Studio 4. The Studio 4 always reflects the current setup of this window. The Studio 4 remembers this setup when you close the Network

Routing window (or you make another window active). If you want your Studio 4 to remember the most recent Network Routing configuration, turn it off only *after* closing or de-activating this window.

## Multiple Studio 4's

If you have either one or two Studio 4's in a single network, you'll have only one Network Routing window. That window's title bar indicates whether your network is connected to the Modem port, the Printer port, or both (2 cables).

If you have two Studio 4 networks (one network connected to each Macintosh serial port), you'll have two Network Routing windows (one for each port). From the **Studio 4** menu, choose any Studio 4 on the modem port to open the Network Routing window for the modem port. Choose any Studio 4 on the printer port to open the Network Routing window for the printer port.

## SETTING THE MIDI INPUTS

The left side of the Network Routing window contains the MIDI In columns. These columns control the signal routing from each MIDI device to the Macintosh. You can also route the timecode signal generated by the Studio 4.

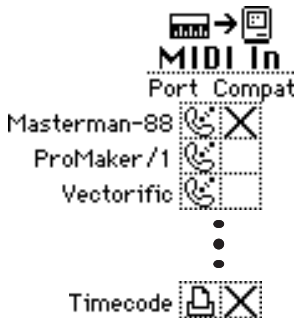

Figure 6.3: Network Routing Window's MIDI Input Side

### MIDI In Port Column

If you connect both Macintosh serial ports to a network (consisting of either one or two Studio 4's), you can select which serial port each device uses to communicate with the Macintosh. You can switch between ports by clicking the port icon in the Port column. Choose either the Printer port or the Modem port for each device. You can also choose to route timecode (as generated by the Studio 4) to either the Macintosh Printer or Modem port. Click and drag down the Port column to change many port assignments quickly.

Use the MIDI In Port column to balance the MIDI input data between the two Macintosh serial ports. For instance, timecode data is very dense—so to prevent timing errors, you should always route timecode to the least used serial port (ideally, its own port).

In Figure 6.3, data from the Masterman-88, ProMaker/1 and Vectorific is sent to the Macintosh Modem port. Timecode is sent to the Macintosh Printer port.

If you connect only one Macintosh serial port to a Studio 4 (or pair of Studio 4's), the Port column merely illustrates which Macintosh port is used; you can't change the port assignment by clicking it.

**TIMECODE NOTE:** *The Macintosh can handle only one incoming timecode stream per serial port. If you're using multiple Studio 4's, it's up to you to make sure that no more than one Studio 4 per port is sending timing information to the Macintosh.*

### MIDI In Compatibility Column

Use the Compatibility (Compat) column to enable device inputs when you work with non-OMS software. Click each device's Compatibility column to toggle between enabled (checked) and disabled (unchecked). Click and drag down the Compatibility column to change multiple compatibility settings.

In Figure 6.3, only timecode and MIDI data from the Masterman-88 are sent to non-OMS applications. MIDI data from the ProMaker/1 and Vectorific sound modules will not be sent to non-OMS applications.

**IMPORTANT:** *If you're using non-OMS MIDI applications, you MUST enable devices in the MIDI In Compatibility column in order for MIDI data to be sent to the application. This is true even for non-OMS applications that work with the MIDI Time Piece (such as Performer).*

## SETTING THE MIDI OUTPUTS

The right side of the Network Routing window contains the MIDI Out columns. These columns control the signal routing from the Macintosh to each MIDI device defined in your current Studio Setup document.

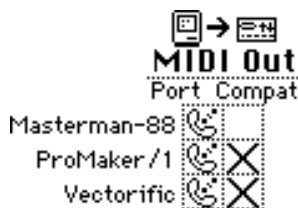

Figure 6.4: Network Routing Window's MIDI Output Side

## MIDI Out Port Column

If you connect both Macintosh serial ports to a network (consisting of either one or two Studio 4's), you can select which serial port each device uses to communicate with the Macintosh. You can switch between ports by clicking the port icon in the Port column. Choose either the Printer port or the Modem port for each device. Click and drag down the Port column to change many port assignments quickly.

Use the MIDI Out Port column to balance the MIDI output data between the two Macintosh serial ports.

In Figure 6.4, data from the Macintosh is sent to the Masterman-88, ProMaker/1 and Vectorific via the Modem port.

If you connect only one Macintosh serial port to a Studio 4 (or pair of Studio 4's), the Port column merely illustrates which Macintosh port is used; you can't change the port assignment by clicking it.

## MIDI Out Compatibility Column

When you work with non-OMS applications, use the Compatibility (Compat) column to enable the flow of MIDI from the Macintosh to each device. Click each device's Compatibility column to toggle between enabled (checked) and disabled (unchecked). Click and drag down the Compatibility column to change multiple compatibility settings.

In Figure 6.4, data from non-OMS applications is sent to only the modem port and to the ProMaker/1 and Vectorific sound modules. Non-OMS applications will not send MIDI data to the Masterman-88 since its Compatibility column isn't checked.

**MIDI TIME PIECE NOTE:** *Applications that work with the MIDI Time Piece will send MIDI to the correct outputs, regardless of whether the output Compatibility check boxes are checked.*



---

## CHAPTER 7: Routing, Channelizing and Muting Window

### WHEN TO USE THE ROUTING, CHANNELIZING AND MUTING WINDOW

Use this window to set and view all of the routing, channelizing and muting settings in the Studio 4. All settings are retained by the Studio 4 and, along with the settings in the Network Routing window, can be saved to the Macintosh as a Studio 4 state (see Chapter 8).

The Routing, Channelizing and Muting window (RCM window, for short) is used for:

- Routing MIDI data (including timecode)  
For example, in a “live” situation you might route various controllers to various devices or groups of devices. You can even merge any combination of MIDI inputs so that more than one controller can play the same MIDI device.
- Channelizing MIDI data  
You could, for example, change the transmit or receive channel of an older “fixed-channel” MIDI device.

- Muting unnecessary MIDI data  
For example, if your master keyboard generates aftertouch, but you don't want some of your sound modules to respond to aftertouch, you could mute the aftertouch outputs to those devices.

**NOTE:** *MIDI routing can also be performed by a sequencer or by OMS patches (discussed in the Studio Patches Editor manual). If you've designed a routing in the Routing, Channelizing and Muting window that doesn't seem to perform properly, make sure that your sequencer (or OMS patch) doesn't have a conflicting routing scheme. It's up to you to keep track of MIDI routings.*

## WINDOW OVERVIEW

Choose **MIDI Routing, Channelizing and Muting** from the **Studio 4** menu to open the Routing, Channelizing and Muting window.

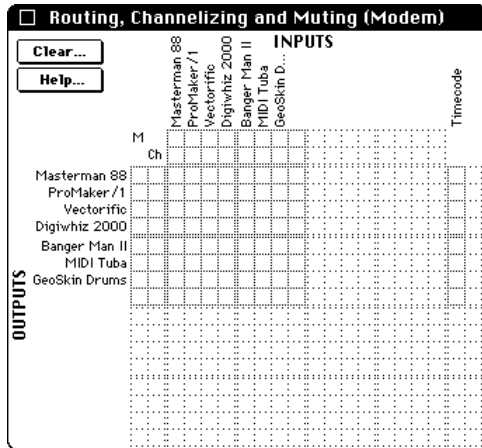

**Figure 7.1: Routing, Channelizing and Muting Window**

When you open an RCM window it reflects the current Routing, Channelizing and Muting setup of the Studio 4.

Four separate areas make up the Routing, Channelizing and Muting grid. These areas are illustrated in Figure 7.2 and are discussed later in this chapter.

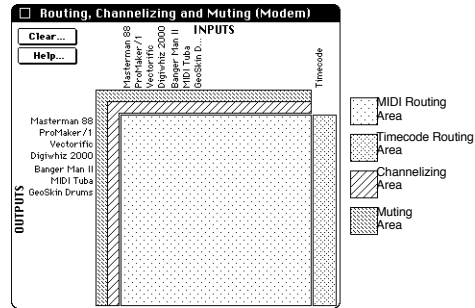

**Figure 7.2: RCM Window Block Diagram**

When you edit this window, the changes are sent immediately to the Studio 4. The Studio 4 always reflects the current setup of this window. The Studio 4 remembers this setup when you close the RCM window (or you make another window active). If you want your Studio 4 to remember the most recent MIDI Routing, Channelizing and Muting configuration, turn it off *after* closing or de-activating the RCM window.

### RCM Window with a Single Studio 4

Notice that the MIDI Routing Area is a sixteen row by sixteen column grid. Each column represents one of sixteen Studio 4 MIDI inputs and each row represents one of sixteen Studio 4 MIDI outputs. However, a single Studio 4 has only eight MIDI inputs and eight MIDI outputs. If your Studio Setup document contains



only one Studio 4, you'll use only the first eight rows and columns in the MIDI Routing, Channelizing and Muting areas. Also, you'll use only eight of the timecode routing squares.

The RCM window illustrates its active regions by dimming all unused portions of the grid as shown in Figure 7.1. The window's title bar indicates whether the Studio 4 is connected to the Modem port, Printer port, or both (2 cables).

### RCM Window with Two Studio 4's in a Single Network

If you have a second Studio 4 connected as shown in Figure 7.3, your Studio 4 network contains sixteen MIDI ins and sixteen MIDI outs. Rows 9-16 and columns 9-16 represent the second Studio 4.

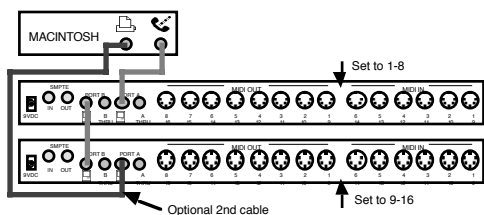

Figure 7.3: Two Networked Studio 4's

As shown in Figure 7.4, the entire RCM window grid is active when you connect two Studio 4's to a single network. Also, notice that both Studio 4's are represented in the timecode routing area. The window's title bar indicates whether the network is connected to the Modem port, Printer port, or both (2 cables).

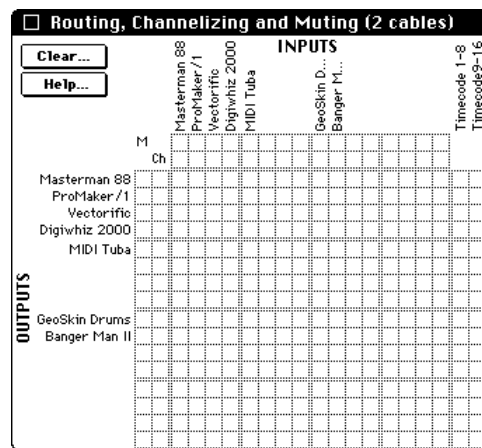

Figure 7.4: RCM Window for Two Studio 4's in a Single Network

### RCM Window with Two or More Studio 4's in Two Networks

As discussed in the previous sections, if you have either one or two Studio 4's in a single network (or a 2-cable network), you'll have only one Routing, Channelizing and Muting window.

However, if you have two Studio 4 networks (one network connected to each Macintosh serial port), you'll have two Routing, Channelizing and Muting windows (one for each port). From the

**Studio 4** menu, choose any Studio 4 on a modem port to open the Routing, Channelizing and Muting window for the modem port. Choose any Studio 4 on a printer port to open the Routing, Channelizing and Muting window for the printer port. If a network has only one Studio 4, its RCM window uses only the 8x8 grid. If a network contains two Studio 4's, its RCM window uses the entire grid.

## MIDI MUTING

MIDI muting allows you to mute notes, program changes, mono or polyphonic aftertouch, pitch bend, controllers, active sensing, beat clock, timecode, system exclusive and miscellaneous system events at either the Studio 4's input or its output.

This is very useful for thinning the MIDI data stream by muting unused or undesired MIDI messages.

**NOTE:** *Beat clock messages include Song Position Pointer, Song Select, Timing Clock, Start, Stop and Continue messages. Miscellaneous system events include Tune Request, System Reset and undefined MIDI status bytes 0xF4, 0xF5, 0xF9, and 0xFD.*

## Using MIDI Muting

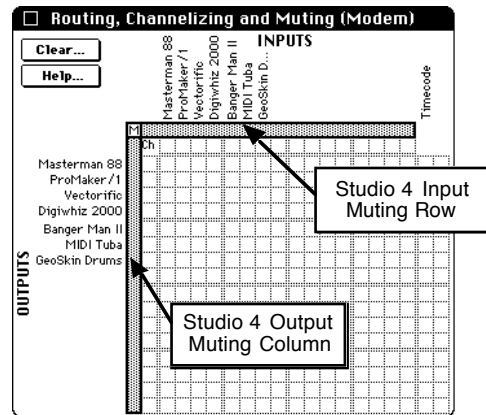

Figure 7.5: MIDI Muting Area

Use the horizontal MIDI muting *row* (designated by an “M”) to mute MIDI messages arriving at the Studio 4 MIDI inputs. Use the vertical MIDI muting *column* to mute MIDI messages leaving the Studio 4 MIDI outputs.

Click one of the muting squares (as shown in Figure 7.6).

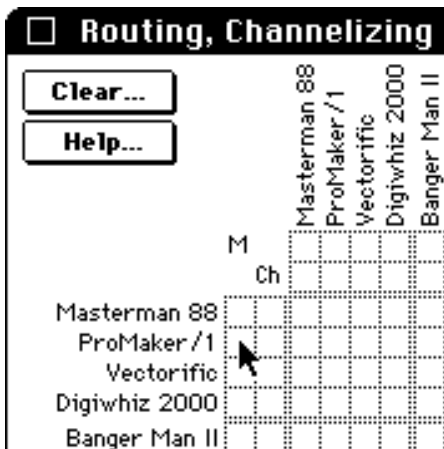

Figure 7.6: Click to Open Mute Window

A Mute window opens similar to Figure 7.7.

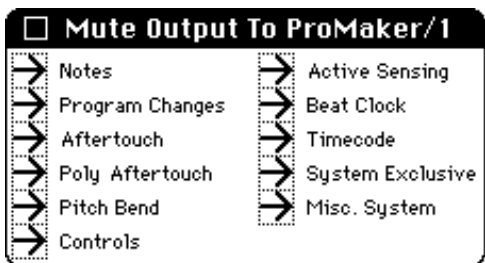

Figure 7.7: Default Mute Window

You can elect to mute up to eleven types of MIDI data. A MIDI message which is passed (not muted) is indicated by an arrow.



MIDI data which is muted is indicated by the international "NO" symbol.



You can toggle between muted and unmuted MIDI messages by clicking the icons.

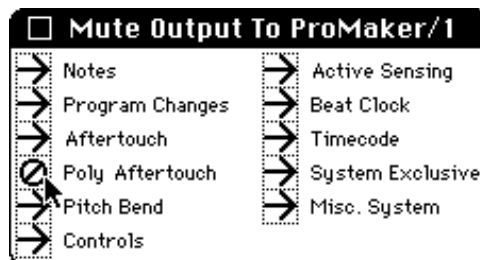

Figure 7.8: Click to mute/unmute

Figure 7.8 shows a mute configuration that removes polyphonic aftertouch from the MIDI data sent to the ProMaker/1.

When you have muted one or more MIDI messages, an “M” appears in the appropriate location in the Routing, Channelizing and Muting window.

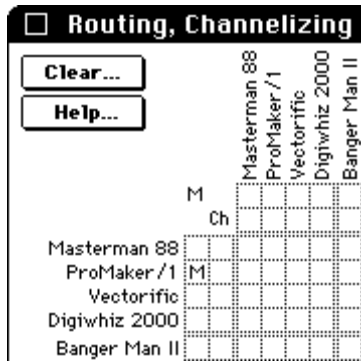

Figure 7.9: MIDI Muting Indicator

## MIDI CHANNELIZING

Use MIDI channelizing to change the MIDI channel number of data either entering or exiting the Studio 4.

MIDI channelizing is particularly useful if you have devices (usually older MIDI equipment) that transmit or receive on a fixed channel. You can use MIDI channelizing to change a fixed MIDI channel.

## Using MIDI Channelizing

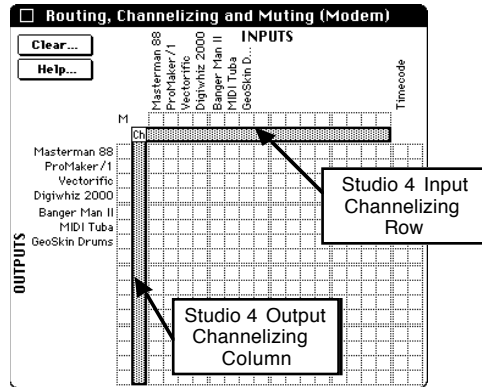

Figure 7.10: MIDI Channelizing Area

Use the MIDI channelizing *row* (designated by a “Ch”) to rechannel incoming MIDI messages. Use the MIDI channelizing *column* to rechannel outgoing messages.

Click one of the channelizing squares (as shown in Figure 7.11).

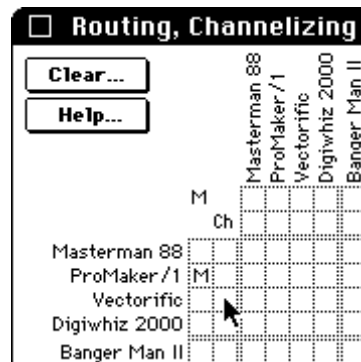

Figure 7.11: Click to Open Channelizing Window

A Channelizing window opens similar to Figure 7.12.

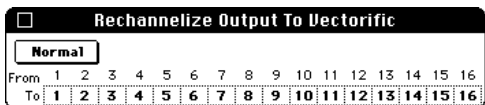

Figure 7.12: Default Channelizing Window

The top row of numbers represent the 16 possible MIDI channels. Change the bottom row of bold-faced numbers to change the MIDI channel.

You can change each MIDI channel number to any other channel number (1-16) or you can mute (turn “Off”) a channel.

The **Normal** button removes all MIDI channelizing and returns the window to its default state.

**NOTE:** *The bold-faced numbers are called “numericals”. Numerical editing is common to all Opcode applications. If you’re unfamiliar with numericals or new to Opcode applications, please read “Appendix A: Working with Opcode Applications” in your OMS Manual.*

Figure 7.13 illustrates a simple MIDI channelizing example.

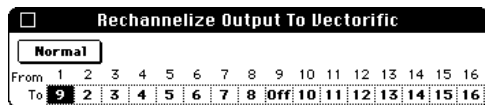

Figure 7.13: MIDI Channelizing Example

The MIDI channelizing shown in Figure 7.13 mutes data on Channel 9, thus blocking its transmission to the Vectorific. It then takes the data from Channel 1 and remaps it to Channel 9 in the Vectorific.

When you have channeled one or more MIDI messages, a “Ch” appears in the appropriate location in the Routing, Channelizing and Muting window.

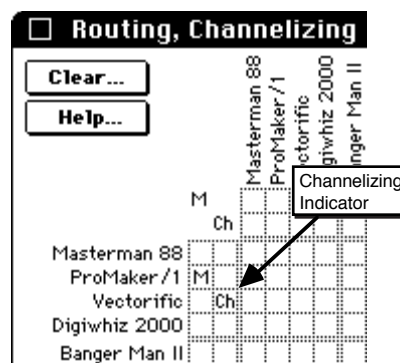

Figure 7.14: MIDI Channelizing Indicator

## MIDI ROUTING

Use MIDI routings to establish MIDI communication between various devices. MIDI routings have many uses, including:

- Building MIDI stacks (many instruments playing on the same MIDI channel).
- Assigning instruments in a MIDI band.
- MIDI merging.

## Using MIDI Routing

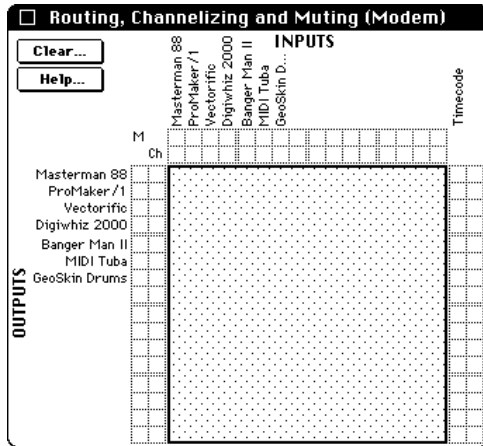

Figure 7.15: MIDI Routing Area

Click one of the squares in the 16 X 16 grid (as shown in Figure 7.16) to create a MIDI routing.

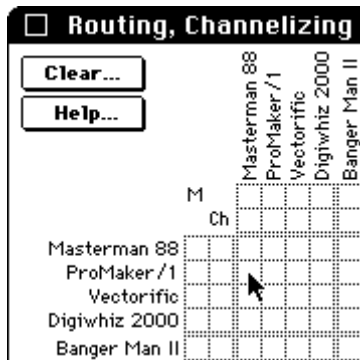

Figure 7.16: Clicking the MIDI Routing Grid

When you click an empty square, a small MIDI routing arrow appears.



A MIDI routing arrow points from an input device at the top of the window to an output device at the left. This indicates the direction of MIDI flow.

When you click an arrow, it disappears and the routing is removed.



In Figure 7.17, the MIDI routing arrow indicates that MIDI is routed from the Masterman-88 keyboard to the ProMaker/1 sound module. The ProMaker/1 plays on the same MIDI channel transmitted by the Masterman-88.

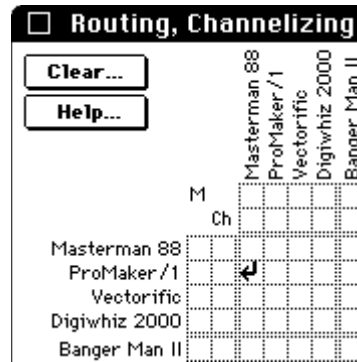

Figure 7.17: Simple MIDI Routing

## MIDI Routing Examples

You can create “MIDI stacks” by routing one input to more than one output. In Figure 7.18 one arrow routes the Masterman-88 to the ProMaker/1 and the other routes the Masterman-88 to the Vectorific sound module. With this setup, the Masterman-88 plays both synthesizers on the same MIDI channel transmitted by the Masterman-88.

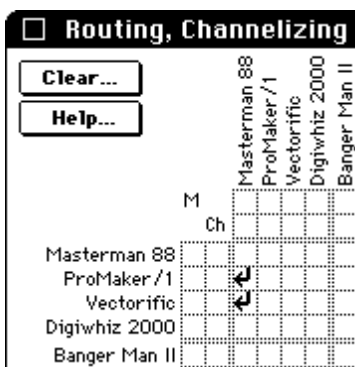

Figure 7.18: Simple MIDI Stack Routing

You can route your entire band through the Studio 4. Look at the MIDI routing in Figure 7.19 and notice that the Masterman-88 plays the ProMaker/1, the GeoSkin drum pads control the Banger Man II drum machine, and the MIDI Tuba plays a Vectorific/Digiwhiz 2000 MIDI stack.

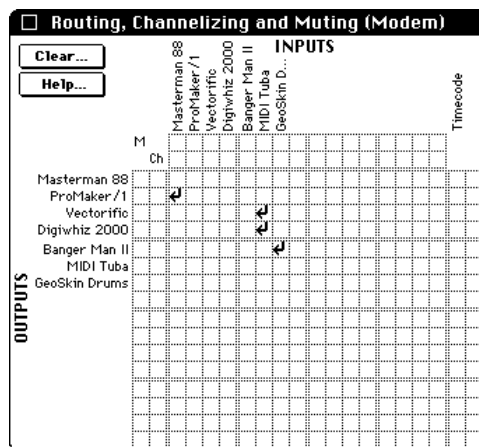

Figure 7.19: Simple MIDI Band Routing

## Routing Caveat

There are two instances when it may *not* be desirable to define any MIDI routings:

- When using a sequencing application  
Most sequencers (such as Vision or Performer) control MIDI routing within the application. You use the sequencer to route MIDI inputs to MIDI outputs. Be aware that these routings can be active at the same time as routings established in the RCM window and, unless your careful, could cause unwanted MIDI thruing and extra sounds.
- When using an OMS patch  
OMS patches (discussed in the Studio Patches Editor manual) allow you to design very advanced MIDI routing and processing paths using the Macintosh (instead of the Studio 4) to process MIDI data. Be

aware that these routings can be active at the same time as routings established in the RCM window and, unless your careful, could cause unwanted MIDI thruing and extra sounds.

Experienced users will find many instances when it's convenient to use multiple routing methods, but novices may be overwhelmed if they try to use more than one method at a time. The important thing to remember is that sequencers, OMS patches and the RCM window all affect MIDI routing. You can use these various methods together, but you should plan your MIDI routing scheme carefully to avoid confusion.

You may wish to define a Routing, Channelizing and Muting window without any routings at all. You can save this window as a Studio 4 state and recall it whenever you work with sequencers or OMS patches that control MIDI routing. See “Establishing a Do Nothing State” in Chapter 8.

## TIMECODE ROUTING

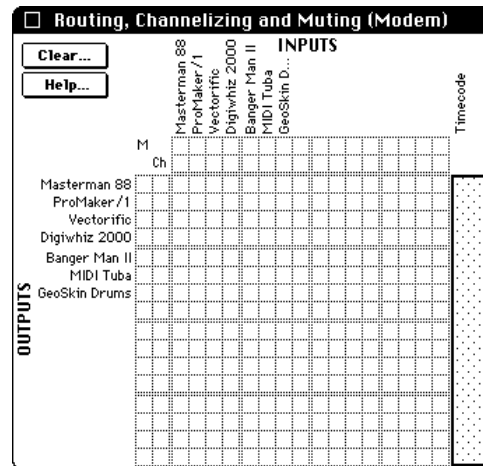

Figure 7.20: Timecode Routing Area

The timecode routing area is shown in Figure 7.20. This grid is very similar to the MIDI routing grid—you click one of the squares to route timecode (as generated by the Studio 4) to a MIDI device. The timecode’s MIDI format (MTC, DTL, or DTLe) is chosen in the Stripe SMPTE window (see Chapter 10). Timecode routing sends only MTC, DTL, or DTLe. It does not send MIDI Clock or Song Position Pointer.

You usually use timecode routing to send MTC (or a DTL format) from the Studio 4 to an external non-computer sequencer (such as a stand-alone hardware sequencer or a sequencer contained in a MIDI “workstation”).



There are two timecode columns:

- The column on the left always represents the Studio 4 assigned to MIDI ports 1-8.
- The column on the right always represents the Studio 4 assigned to MIDI ports 9-16.

If your network contains only one Studio 4, then the RCM window will look like Figure 7.21. Use the left column (labeled “Timecode”) to route timecode from the Studio 4 to any MIDI device(s). The right column is not used and is unlabeled since there is only one Studio 4.

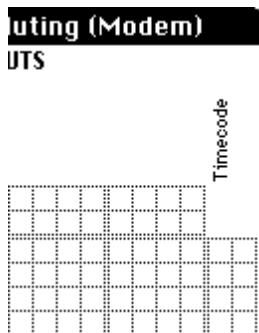

Figure 7.21: Timecode Routing Area with One Studio 4 in Network

If your network contains two Studio 4’s, then the RCM window will look like Figure 7.22. Use the left column (labeled “Timecode 1-8”) to route timecode from the Studio 4 assigned to MIDI ports 1-8. Use the right column (labeled “Timecode 9-16”) to route timecode from the Studio 4 assigned to MIDI ports 9-16.

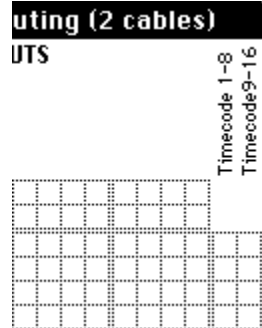

Figure 7.22: Timecode Routing Area with Two Studio 4’s in Network

## MIDI BEAT CLOCK ROUTING

Routing MIDI Beat Clock with the Studio 4 requires special consideration since the Studio 4 can route only one source of MIDI beat clock at a time. If you try routing two or more separate beat clock sources into the Studio 4, they will merge together making synchronization impossible.

**IMPORTANT:** *Never route more than one source of MIDI Beat Clock to the Studio 4 at any time. Always use the RCM window to mute any unnecessary beat clock inputs and outputs.*

The most common use of MIDI beat clock is to synchronize drum machines and hardware sequencers to each other or to a Macintosh MIDI sequencer. The following sections discuss some common beat clock routing problems and their solutions.

## Syncing a MIDI Application to a Drum Machine

To synchronize a Macintosh MIDI sequencer to a drum machine:

- ① **Open the Studio 4 Mute Input window for the drum machine and make sure beat clock is not muted.**
- ② **Mute beat clock on all other Studio 4 input ports.**

It's very important that beat clock from only one source reaches the Studio 4. In this example, that beat clock source is the drum machine.

- ③ **Mute beat clock on all Studio 4 output ports.**

Muting unused beat clock outputs saves processing time and prevents MIDI logjams.

These three steps are illustrated in Figure 7.23. They assure that beat clock from only the drum machine reaches the Studio 4, and that no beat clock is sent to any connected devices.

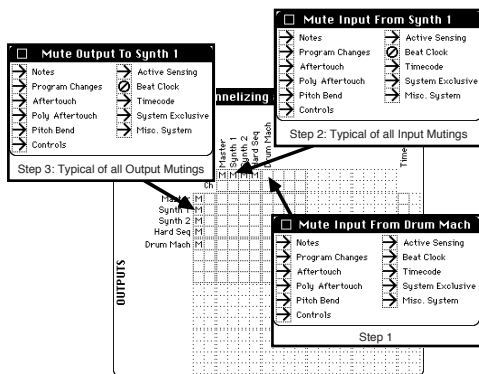

Figure 7.23: RCM Window Muting Example 1

- ④ **Open your Macintosh MIDI sequencer and choose MIDI Beat Clock as your synchronization mode.**
- ⑤ **In your Macintosh MIDI sequencer, choose the Studio 4 as your sync source.**

Figure 7.24 illustrates the proper selections in Vision. Other sequencers have similar ways to select synchronization modes and devices—see their manuals if necessary.

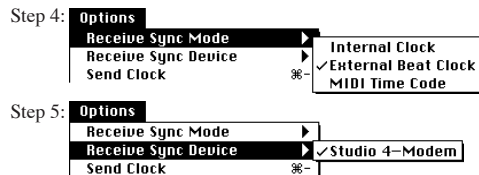

Figure 7.24: Syncing Vision to Drum Machine

## Syncing a Drum Machine to a MIDI Application

To synchronize a drum machine to a Macintosh MIDI sequencer:

- ① **Open the Studio 4 Mute Output window for the drum machine and make sure beat clock is not muted.**
- ② **Mute beat clock on all other Studio 4 output ports.**

Muting unused beat clock outputs saves processing time and prevents MIDI logjams.

- ③ **Mute beat clock on all Studio 4 input ports.**

It's very important that beat clock from only one source reaches the Studio 4. In this example, that beat clock source is the Macintosh.

These three steps are illustrated in Figure 7.25. They assure that beat clock enters the Studio 4 from *only* the Macintosh MIDI sequencer and reaches only the drum machine.

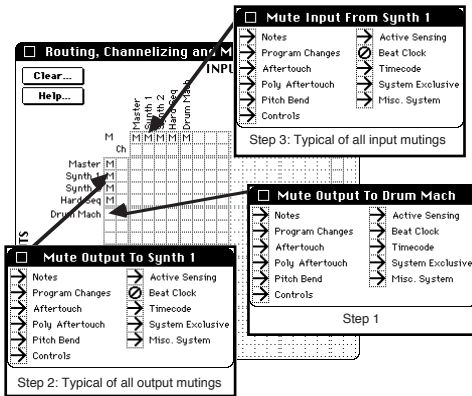

Figure 7.25: RCM Window Muting Example 2

- ④ Open your Macintosh MIDI sequencer and enable the option that allows it to send MIDI beat clock.
- ⑤ In your Macintosh MIDI sequencer, choose the Studio 4 as the device to which you send MIDI beat clock.

In Vision, steps 4 and 5 are performed by enabling “Send Clock” in the Options menu and by choosing the Studio 4 from the list of Send Clock Devices. Other sequencers have similar ways to enable clock output and devices—see their manuals if necessary.

**NOTE:** *If you want to sync multiple devices to a Macintosh MIDI sequencer, simply unmute the clock outputs to each device.*

## Syncing a Hardware Sequencer to a Drum Machine

To synchronize a hardware sequencer to a drum machine:

- ① Open the Studio 4 Mute Input window for the drum machine and make sure beat clock is not muted.
- ② Mute beat clock on all other Studio 4 input ports.

It's very important that beat clock from only one source reaches the Studio 4. In this example, that beat clock source is the drum machine.

- ③ Open the Studio 4 Mute Output window for the hardware sequencer and make sure beat clock is not muted.
- ④ Mute beat clock on all other Studio 4 output ports.

Muting unused beat clock outputs saves processing time and prevents MIDI logjams.

These four steps are illustrated in Figure 7.26. They assure that beat clock from only the drum machine reaches the Studio 4, and that beat clock is sent to only the hardware sequencer.

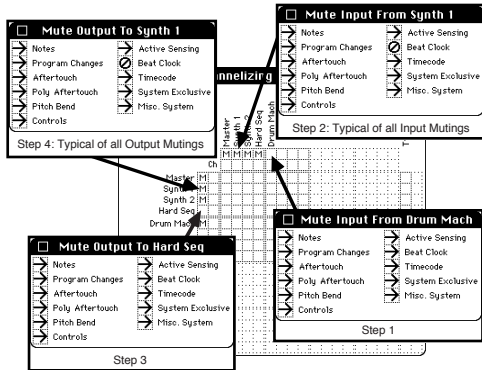

**Figure 7.26: RCM Window Muting Example 3**

Click the **Clear** button to open the following dialog box.



**Figure 7.28: Clear Dialog Box**

Click each check box to select the routing, channelizing or muting shown to its right. Then click the **Clear** button to remove all checked functions.

Click the **Clear Everything** button to clear ALL routings, mutings, and channelizing.

Click **Cancel** to close the dialog box without clearing anything.

## THE CLEAR AND HELP BUTTONS

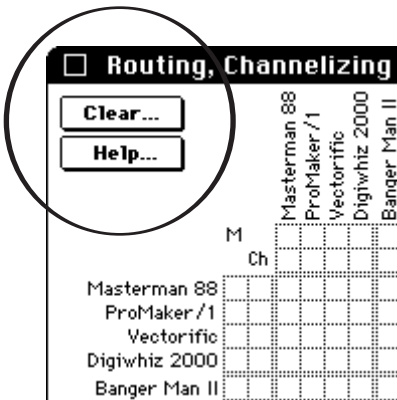

**Figure 7.27: Clear and Help Buttons**

Click the **Help** button to open on-line Routing, Channelizing and Muting window help.

---

## CHAPTER 8: Saving and Opening Studio 4 State Documents

The combination of the Network Routing window setup and the MIDI Routing, Channelizing and Muting window setup is called a Studio 4 state. You can save Studio 4 states as documents and open them at any time. When you open a Studio 4 state document, it sets the state of the Studio 4 and updates the Network Routing window and the RCM window. A single state document contains Network Routing window and RCM window data for all Studio 4's on all networks. You can save as many Studio 4 state documents as you need.

The Studio 4 remembers its most recent state even after the power is turned off.

---

### SAVING A STUDIO 4 STATE DOCUMENT

To save the Network Routing setup and the MIDI Routing, Channelizing and Muting setup as a Studio 4 state document:

- ① **Configure the Network Routing window and the MIDI Routing, Channelizing and Muting window as desired.**

- ② **Choose **Save** from the **Studio 4** menu.**

A standard Macintosh save as dialog box appears.

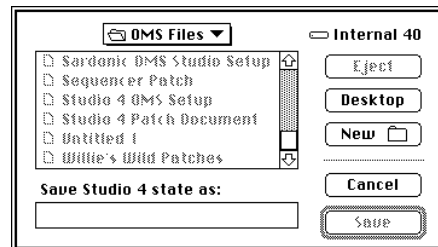

Figure 8.1: Saving a Studio 4 State

- ③ **Type a name for the state and select the disk or folder in which you wish to store it.**
- ④ **Click **Save** to store the Studio 4 state.**

Each Studio 4 state document contains:

- Network Routing window settings for each interface in the current Studio Setup.
- MIDI Routing, Channelizing and Muting window settings for each interface in the current Studio Setup.

## Saving a State Document Under a Different Name

Sometimes, you may modify a Studio 4 state without wishing to overwrite the original state document. In this case, you should choose the **Save As** command from the **Studio 4** menu to save the modified state under a different name.

---

## OPENING A STUDIO 4 STATE DOCUMENT

To open a Studio 4 state document:

- Choose **Open** from the **Studio 4** menu. A standard Macintosh open dialog box will appear.

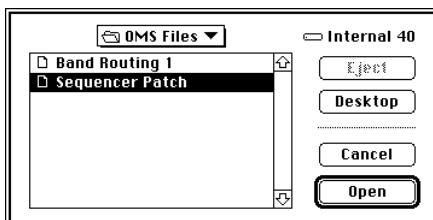

**Figure 8.2: Opening a Studio 4 State**

Select the file you wish to open.

- Click **Open** to load the new Studio 4 state.

The new Studio 4 state document will replace:

- The Network Routing window settings for each interface in the current Studio Setup.

- The MIDI Routing, Channelizing and Muting window settings for each interface in the current Studio Setup.

---

## ESTABLISHING A "DO NOTHING" STATE

As an example, you'll create a "Do Nothing" state in this section. The "Do Nothing" state has no routings, mutings or MIDI channelizing. It's a convenient starting place from which to build other Studio 4 state documents, and is also convenient to use with sequencers or OMS patches.

To define a "Do Nothing" state:

- ① **Set the Network Routing window (if required) to the desired conditions.**
- ② **Open the MIDI Routing, Channelizing and Muting window.**
- ③ **Click the Clear button**

- ④ Click the **Clear Everything** button in the resulting dialog box.



**Figure 8.3: Clearing all Routings, Mutings and Channelizing**

This will clear all routings, mutings and MIDI re-channelizations.

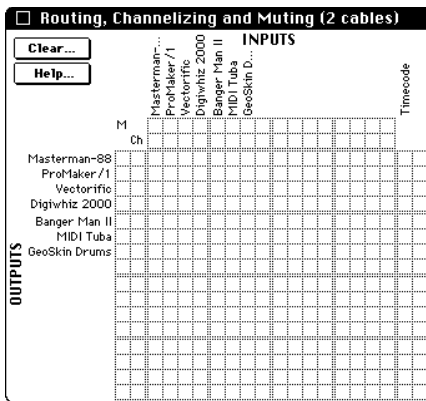

**Figure 8.4: A “Do Nothing” Routing**

- ⑤ Choose **Save** from the **Studio 4** menu, type a suitable name for the Studio 4 state, then click the **Save** button.

Now, any time you need to set your Studio 4 to a “Do Nothing” state, simply open this state document with the **Open** command in the **Studio 4** menu.





---

## CHAPTER 9: SMPTE Reader Window

Choose **SMPTE Reader** from the **Studio 4** menu to open the SMPTE Reader window.

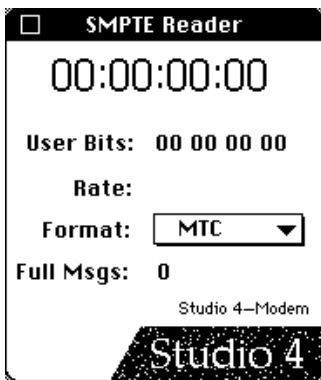

Figure 9.1: SMPTE Reader Window

---

### USING THE SMPTE READER WINDOW

From top to bottom, the SMPTE Reader window contains a timecode display, User Bits display, Rate display, Format pop-up menu and Full Message display. These are discussed in the following sections.

#### Timecode Display

This window displays the SMPTE timecode signal received at the SMPTE IN jack on the Studio 4 unless the Studio 4 is striping tape; then it displays the SMPTE time being striped. It uses the MIDI format (MTC/DTL/DTLe) set in the **Format** pop-up menu.

**NOTE:** *The SMPTE Reader cannot distinguish between 29.97 non-drop and 30 non-drop. When the Studio 4 is reading 29.97 non-drop SMPTE, the SMPTE Reader will display the rate as 30 non-drop.*

#### User Bits Display

If you choose MTC from the **Format** pop-up menu, then any user bits that are encoded with the SMPTE timecode are displayed in the user bits display. User bits cannot be read if you use DTL or DTLe as the MIDI synchronization format.

For more information about user bits, see Chapter 10.

#### Rate Display

This area displays the SMPTE frame rate of the incoming SMPTE signal.

## Format Menu

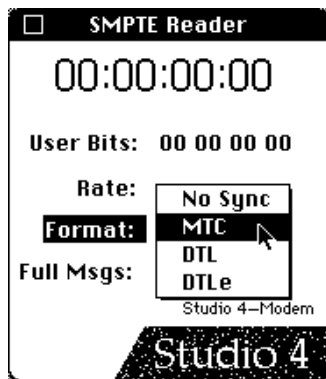

Figure 9.2: Setting MIDI Format

From the **Format** pop-up menu, choose the MIDI sync format your software uses. This pop-up menu duplicates the **MIDI Format** pop-up menu found in the SMPTE Reader window (discussed in Chapter 10). The Studio 4 converts SMPTE timecode into the MIDI format set in this pop-up menu. The choices are:

- **No Sync:** The Studio 4 ignores the SMPTE input signal. Also, it doesn't show timecode when striping.
- **MTC:** The Macintosh uses MIDI Time Code to read the value of the SMPTE signal.
- **DTL:** The Macintosh uses Direct Time Lock to read the value of the SMPTE signal.
- **DTLe:** The Macintosh uses Enhanced Direct Time Lock to read the value of the SMPTE signal.

**DTL NOTE:** *There is one important point you need to consider when using either Direct Time Lock or Enhanced Direct Time Lock: DTL and MIDI Beat Clock use identical messages. Consequently, any MIDI Beat Clock messages received by the Studio 4 merge with DTL messages generated by the Studio 4, making both messages unreadable. Therefore, when you sync your sequencer to DTL, you must not allow any devices to send MIDI Beat Clock to the Macintosh. Either stop the device from sending MIDI Beat Clock, mute the MIDI Beat Clock messages in the RCM window or use MIDI Time Code instead of DTL.*

## Full Message Display

If you choose MTC as the MIDI format, then every time the Studio 4 achieves sync, it generates a “Full Message”. During a normal syncing situation, you will get only one full message (when the Studio 4 initially locks to tape). If the tape is of poor quality or the SMPTE signal isn't strong enough, additional full messages are sent. Each full message increments the counter and provides a good way to check the quality of your tape or incoming SMPTE signal. The SMPTE Reader window doesn't display Full Messages when you use DTL or DTLe as the MIDI synchronization format.

## USING WITH MULTIPLE STUDIO 4'S

The SMPTE Reader displays the time-code received at the SMPTE IN jack of the selected Studio 4. You must select a Studio 4 from the bottom of the **Studio 4** menu *before* opening the SMPTE Reader window. The SMPTE Reader window isn't affected by new Studio 4 selections after it's open—the window continues to work with the Studio 4 that was selected before it was opened. The SMPTE Reader window shows the name of the Studio 4 with which it works.



**Figure 9.3: Studio 4 Identification in SMPTE Reader Window**

**NOTE:** *If you have two Studio 4's connect in a 1-Network/1-Cable fashion (see Chapter 3), then you should use the Studio 4 connected directly to the Macintosh for SMPTE functions.*



# CHAPTER 10: Stripe SMPTE Window

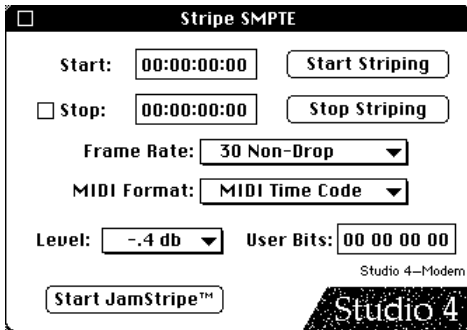

Figure 10.1: Stripe SMPTE Window

Choosing **Stripe SMPTE** from the **Studio 4** menu opens the window shown above. The following sections discuss the mechanics of this window. See the SMPTE tutorial later in this chapter for a step-by-step striping guide.

## SETTING AND USING START AND STOP TIMES

The **Start** field contains the SMPTE start time. Reading from left to right, the numbers represent hours, minutes, seconds, and frames.



Figure 10.2: SMPTE Start Field

The Studio 4 can stop generating time code automatically. This is especially useful for unattended striping sessions. You can enter a stop time value in the **Stop** field. The check box to the left of the **Stop** field turns on the automatic stop feature. If the box is checked *and* a value is entered into the **Stop** field, the Studio 4 will automatically stop sending SMPTE timecode when that value is reached. If the box is not checked, the Studio 4 will ignore the Stop value, and continue striping until the **Stop Striping** button is clicked.



Figure 10.3: SMPTE Stop Field

The Studio 4 will begin to generate SMPTE timecode from its SMPTE Out jack as soon as the **Start Striping** button is clicked. The SMPTE value will begin at the time specified in the Start field. The

Studio 4 will cease to generate SMPTE timecode when the **Stop Striping** button is clicked (or when the Stop field value is reached and the Stop check box is checked).

**NOTE:** *The Stop check box must be checked BEFORE clicking the Start Striping button. If you check the Stop check box AFTER clicking Start Striping, then striping will not stop automatically.*

As an example, let's say you wanted to stripe a tape with exactly 33 minutes of time code, and you wanted this stripe to begin at 1 hour SMPTE time. You would type 01:00:00:00 into your **Start** field, check the Stop check box, enter 01:33:00:00 into your **Stop** field, roll tape, and press the **Start Striping** button.

You can choose one of five SMPTE frame rates from the Frame Rate pop-up menu. When you click the **Start Striping** button, the chosen rate is generated within the Studio 4 and sent to the SMPTE OUT jack. The following is a brief description of the various SMPTE frame rates.

- 24 Frame: Film frame rate.
- 25 Frame: EBU (European) television frame rate.
- 29.97 Drop Frame: NTSC color television frame rate.
- 29.97 Non-Drop: Used to sync to NTSC color television without dropping frames. SMPTE time does not match real-time, but playback pitch is unaffected.
- 30 Non-Drop: Original NTSC black and white television standard. Often used in audio-only situations since there are no dropped frames and the SMPTE time is equal to real time.

## SETTING AND USING SMPTE FRAME RATES

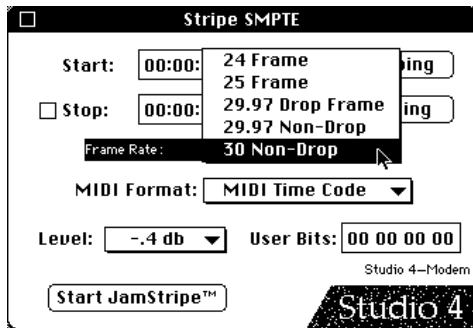

Figure 10.4: Setting SMPTE Frame Rate

## SETTING AND USING THE MIDI FORMAT

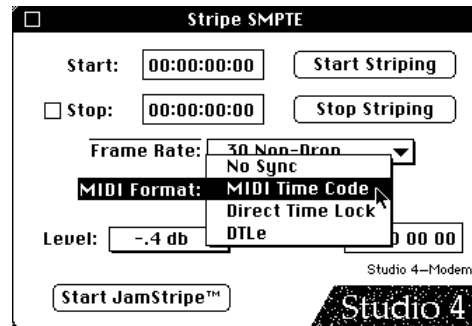

Figure 10.5: Setting MIDI Format

From the **MIDI Format** pop-up menu, choose the MIDI sync format your software uses. This pop-up menu duplicates the **Format** pop-up menu found in the SMPTE Reader window. The Studio 4 converts SMPTE timecode into the MIDI format set in this pop-up menu. The choices are:

- **No Sync:** The Studio 4 ignores the SMPTE input signal. Also, it doesn't show timecode when striping.
- **MTC:** The Macintosh uses MIDI Time Code to read the value of the SMPTE signal.
- **DTL:** The Macintosh uses Direct Time Lock to read the value of the SMPTE signal.
- **DTLe:** The Macintosh uses Enhanced Direct Time Lock to read the value of the SMPTE signal.

## GUIDE TO SETTING SMPTE LEVELS

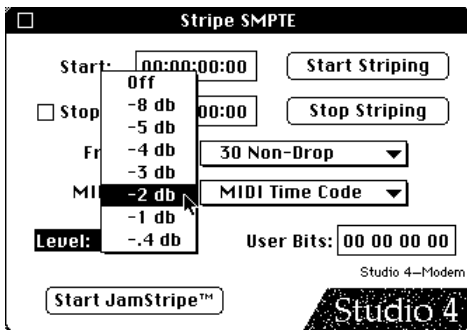

Figure 10.6: Setting SMPTE Output Level

The pop-up **Level** menu lists eight settings for the SMPTE output level. Choose one that provides the best input signal for your particular tape recorder. The following guide covers the optimum input levels for various types of machines. Adjust the **Level** command to give a SMPTE input value closest to the following.

- If your tape machine operates at -10 dB, adjust the SMPTE output level for a tape input of about -3 dB.
- If your tape machine operates at +4 dB, adjust the SMPTE output level for a tape input of about -7dB.
- If you are using a -10 dB machine with LED metering, adjust the SMPTE output level for a tape input between -1 and -2 dB.
- If your audio recorder uses dbx noise reduction and you can't defeat it, adjust the SMPTE output level for a tape input between -1 and 0 dB.
- If you have a mixer in the SMPTE signal path (and you shouldn't), make sure that the equalization is either switched out or flat. Any filtering of the SMPTE signal will render it invalid.

## JAM SYNC

The Studio 4 has a Jam Sync mode. In this mode, it generates a fresh SMPTE signal from the SMPTE OUT jack in sync with the signal received at the SMPTE IN jack. You should always use Jam Sync mode to regenerate a SMPTE track when you copy tapes; a copied SMPTE track may degrade enough to make it unusable.

To put the Studio 4 into Jam Sync mode, choose **Jam Sync** from the **Studio 4** menu. A check next to the **Jam Sync** option means that Jam Sync is enabled. To disable Jam Sync, choose the option again.

If you want to copy a multitrack tape and its SMPTE track, connect the Studio 4 between the two tape recorders and enable **Jam Sync** in the **Studio 4** menu. The Studio 4 will generate a fresh copy of SMPTE from the original tape's signal regardless of any dropouts in the original copy.

If you do not need to regenerate SMPTE (such as when you're using the Studio 4 to sync a sequencing application to tape), you should disable Jam Sync by unchecking it. This frees the Studio 4's microprocessor to handle other MIDI and timing tasks.

---

## **START JAMSTRIPE™ BUTTON**

JamStripe™ takes Jam Sync one step further. If a tape has a very large drop-out in the SMPTE signal, or if the SMPTE signal stops at some point in the tape, JamStripe will cause the Studio 4 to continue generating timecode without having any SMPTE present at the SMPTE IN jack. To stop generating, click the **Stop Striping** button. If you have a tape in need of this kind of service, click the **Start Jam-Stripe™** button when you make a copy of the tape. The Studio 4 will Jam Sync until it reaches the end of the SMPTE signal, at which point it will switch seamlessly into a generating mode.

**NOTE:** *When Jam Syncing or JamStriping, the SMPTE frame rate at the SMPTE OUT jack is the same as that being received at the SMPTE IN jack. The SMPTE Frame Rate pop-up menu has nothing to do with the SMPTE signal in either Jam Sync or JamStripe modes. You can view the actual SMPTE frame rate by using the SMPTE Reader window.*

---

## **USER BITS**

This field allows you to enter user bits as defined by the SMPTE standard. User bits are often used to mark off and identify various sections of a tape. User bits are hexadecimal, so legal values are the numbers 0-9, and the letters A-F.

**DTL NOTE:** *You can stripe timecode that includes user bits regardless of the MIDI synchronization format you specify. However, if you're reading timecode using either DTL or DTLe, user bits will not be displayed in the SMPTE Reader window—you must use MTC.*

---

## **USING WITH MULTIPLE STUDIO 4'S**

The Stripe SMPTE window works with the selected Studio 4. You must select a Studio 4 from the bottom of the **Studio 4** menu *before* opening the Stripe SMPTE window. The Stripe SMPTE window isn't affected by new Studio 4 selections after



it's open—the window continues to work with the Studio 4 that was selected before it was opened. The Stripe SMPTE window shows the name of the Studio 4 with which it works.



Figure 10.7: Studio 4 Identification in Stripe SMPTE Window

## SMPTE TUTORIAL

Follow through these tutorial sections to learn how to stripe a tape with SMPTE timecode and sync to it.

### Striping a Tape

Unless you already have tapes with SMPTE on them, you will need to put SMPTE timecode onto a blank tape. This process is usually called “striping” a tape with SMPTE.

To stripe a new tape with SMPTE timecode, familiarize yourself with the Stripe SMPTE window as well as the operation of your tape recorder. A typical striping operation might go something like this:

- ⑥ Use a new roll of recording tape and turn off any noise reduction on your tape recorder. Do not use any

equalization or alter the SMPTE signal in any way.

- ⑦ Make sure that your Studio 4 is connected as discussed in “Chapter 3: Hardware Installation”.
- ⑧ Choose **Stripe SMPTE** from the **Studio 4** menu to open the Stripe SMPTE window.

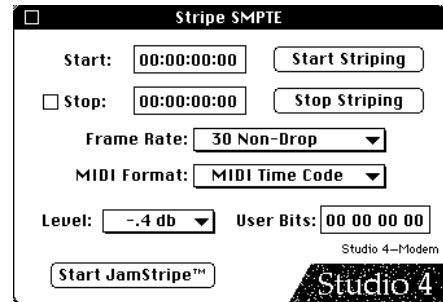

Figure 10.8: Stripe SMPTE Window

- ⑨ Enter the SMPTE frame rate using the **Frame Rate** pop-up menu. Enter a **Start** time. If you wish the striping to stop automatically, enter a **Stop** time and check the **Stop** check box. If desired, enter the **User Bits**. Set a **SMPTE** output level.
- ⑩ Choose a **MIDI Format**.
- ⑪ Put your tape recorder into **Record** mode, but paused.
- ⑫ Click the **Start Striping** button in the **Stripe SMPTE** window.

The Studio 4 SMPTE/Power LED will begin to flash. You should see the SMPTE signal level on your recorder's input meters. Verify that the proper amount of SMPTE signal is going onto tape.

- ⑬ **Adjust, if necessary, either the SMPTE output level on the Mac, or the input level on your tape machine.**
- ⑭ **When you are satisfied with the levels, click the **Stop Striping** button in the Stripe SMPTE window.**
- ⑮ **Choose **SMPTE Reader** from the **Studio 4** menu so that you can monitor the SMPTE time.**
- ⑯ **Turn off the Pause on your audio recorder to begin recording. When tape is rolling, click the **Start Striping** button in the Stripe SMPTE window.**
- ⑰ **SMPTE timecode will stop generating when it reaches the time specified in the **Stop** field if the **Stop** check box is checked.**
- ⑱ **If the **Stop** check box is unchecked, you can click **Stop Striping** when you reach the end of the tape.**
- ⑲ **When you are finished striping, the Studio 4 SMPTE/Power LED will cease to flash. Click the close box to close the Stripe SMPTE window.**
- ③ **Make sure that the Studio 4 is not in Jam Sync mode (the option will not be checked in the **Studio 4** menu).**
- ④ **Open the SMPTE Reader window and choose the MIDI Format that will be sent to the Macintosh (MTC, DTL or DTLe).**
- ⑤ **Put your tape machine into play mode.**
- ⑥ **Verify that the SMPTE/Power LED is flashing. When the Studio 4 detects valid SMPTE code at its input, the SMPTE/Power LED flashes and MIDI Time Code (or, if selected, DTL or DTLe) is sent to the computer.**
- ⑦ **View the SMPTE timecode in the SMPTE Reader window.**

The Studio 4 performs an operation known as “flywheeling”. If your multitrack tape has timecode dropouts, the Studio 4 will continue to send timecode to the Macintosh as if the signal were still present at the input. If the Studio 4 loses sync there could be one of a number of problems. See “Studio 4 loses sync” in “Appendix A: Troubleshooting” for more information.

## **Syncing to Tape**

Once you have a tape with SMPTE striped on it, you can use the Studio 4 to synchronize the Macintosh to the tape.

- ① **Connect the SMPTE track output of your multitrack tape recorder to the Studio 4 SMPTE IN jack (as discussed in the “SMPTE Connections” section of Chapter 3).**
- ② **Connect the computer as discussed in the “Computer Connections” section of Chapter 3.**

## SMPTÉ, Vision and the Studio 4

The following discusses using the Studio 4 with Vision. The information is also applicable to working with Studio Vision.

Vision uses MIDI Time Code for synchronization, so...

Use a similar procedure for recording tracks into Vision while synchronized to tape. For more information concerning Vision's various sync modes, see your Vision manual.

- ① Choose **Stripe SMPTE** from the **Studio 4** menu and choose **MIDI Time Code** from the **MIDI Format** pop-up menu.

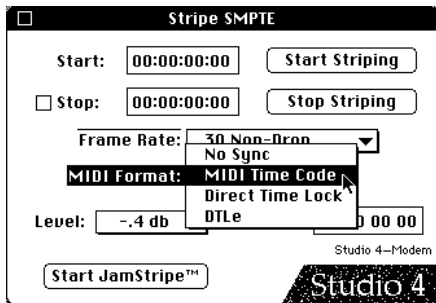

Figure 10.9: Choose MIDI Format

- ② Disable Jam Sync in the **Studio 4** menu.
- ③ Choose **Options>Receive Sync Mode>MIDI Time Code** in Vision.
- ④ Choose **Options>Receive Sync Device>Studio 4** in Vision.
- ⑤ Select the desired playback sequence, its **Sync** and its **Offset**.
- ⑥ Click **Play** in Vision's Control window. The play button will flash while Vision waits for sync.
- ⑦ Hit **Play** on your tape recorder and Vision will start playing back in sync with the tape.



# PART 3: Appendices



---

# APPENDIX A: Troubleshooting

---

## COMMUNICATION PROBLEMS

### You receive an Overrun Error Message on the Macintosh

This message indicates that some information may have been lost by the Macintosh serial port. Too much data is being transmitted too quickly to the Macintosh. Try thinning the MIDI data stream being sent to the Mac. Refer to “Studio 4 Loses Sync” in the “Sync Problems” section for various ways to thin the MIDI data stream.

If thinning the data stream either doesn't help or isn't possible, and you're using Fast mode, you'll need to set a slower Studio 4->Macintosh communication speed. Lower the speed in single step increments until the problem disappears (see Chapter 5).

---

## PERIPHERAL PROBLEMS

### Unresponsive modems, initialized printers, etc.

If the problem peripheral is connected directly to the Macintosh's serial port, you should choose **OMS MIDI Setup** from

the **Edit** menu, uncheck that port's check box, and click **OK**.

If the problem peripheral is connected to the Studio 4, make sure the front panel THRU switch is set to the THRU position.

---

## SYNC PROBLEMS

### Studio 4 will not stripe tape

Make sure the power cord is firmly inserted into its connector, the power switch is on, and that the SMPTE/Power indicator light is lit.

Check all cables between your computer and the Studio 4, and between the Studio 4 and your tape deck.

Check the input level to your tape deck. Set levels as discussed in the “Guide To Setting SMPTE Levels” section in Chapter 10.

### Studio 4 loses sync

Make sure that the heads on your tape deck are clean and that you are using a quality tape in good condition. Old or worn tape contains dropouts that may cause the Studio 4 to lose sync.

If you are syncing to tape, and your sequencer keeps starting and stopping erratically, you are probably losing sync. One possibility is that your SMPTE source is not good. This can be because you have a bad tape or possibly a bad connection from your tape machine to the Studio 4 SMPTE IN jack. This is easy to verify; if the Studio 4 SMPTE indicator light does not start blinking regularly when you try to sync, the Studio 4 is not getting a correct signal. Check your cables and make sure that the recorded SMPTE level is sufficient (see Chapter 10 for a guide to SMPTE recording levels). If the tape was recorded with too high a SMPTE level, then it will have to be re-ripped. If SMPTE was recorded at too low a level, you will need to boost the signal using a preamp or mixer between your tape deck and the Studio 4 SMPTE IN.

If the Studio 4 SMPTE indicator light blinks regularly, then a bad SMPTE signal is not the problem. You may have too much data going from the Studio 4 into the Mac. Some instruments output constant active sensing or MIDI clock messages. MIDI clock messages especially can be a problem, because they are sent more often than active sensing. Or, you could have a device sending MIDI Time Code. You don't need this if you're trying to sync your sequencer to the Studio 4's MIDI Time Code. In general, if you tell a real time application (such as a sequencer) to play, and then send it too much data, it will start to lose some of the data. If it loses timecode data, it will lose sync.

See if any MIDI devices attached to the Studio 4 are transmitting data to the Studio 4 (make sure none of them are playing). Look at the red Studio 4 MIDI In LED's. If any are lit or flashing, you know those devices are constantly sending some kind of data. You can verify if this is the cause of sync loss by turning off or disconnecting the MIDI In cables (from the instrument into the Studio 4) and seeing if the sync problem goes away. If it does, you have a few choices:

- If you can stop the device from sending this data in the first place, do it. Unfortunately, most devices will not let you do this. Typically, the devices that send MIDI clocks have built in sequencers; some of them only send MIDI clocks when their sequencer is actually playing. Others send MIDI clock messages when they are in their "sequencer" mode, and active sensing (which is far less intrusive) when they are not. If you cannot stop the device from sending MIDI clocks, you can set its sequencer to the slowest possible tempo—this results in a slower MIDI clock transmission rate. You can see the tempo change on the Studio 4's MIDI In LED for that device; it will blink slowly at slow tempos, and very rapidly at fast tempos.
- You can mute any unwanted data coming into the Studio 4 using the Routing, Channelizing and Muting window discussed in Chapter 7.



- If you're using only one serial cable between the Macintosh and the Studio 4, try using two. Use the **Network Routing** window in the **Studio 4** menu to route timecode into one port and all other MIDI data into the other.

### **Studio 4 will not sync to tape**

Make sure the power cord is firmly inserted into its connector, the power switch is on, and that the SMPTE/Power indicator light is lit.

Check all the cables between your computer and the Studio 4, and between the Studio 4 and your tape deck.

Verify that the SMPTE/Power indicator light blinks when it is receiving timecode from the tape deck. If not, you may have a bad cable or connection between the Studio 4 and your tape deck. Also, your SMPTE level may be recorded too low. If so, you may need to use a preamp or mixer to boost the SMPTE level before sending it to the Studio 4. See Chapter 10 for proper SMPTE record levels.

Choose **SMPTE Reader** from the **Studio 4** menu, then start the tape. If it displays timecode correctly, the problem is with your application setup, not the Studio 4.

## **MIDI PROBLEMS**

### **More than one instrument sounds on a MIDI channel**

The Routing, Channelizing and Muting window, OMS patches, and MIDI applications (such as sequencers) all control MIDI routing. Most likely, two or more of these settings may be routing the input to different devices.

If the above isn't the cause, then...

- you may be using an OMS patch that contains a splitter routed to more than one device on the same MIDI channel.
- you may be using an OMS patch that references a Virtual Instrument containing a splitter routed to more than one device on the same MIDI channel.
- you may have one input routed to more than one output in the Routing, Channelizing and Muting window.

### **Can't send MIDI to non-OMS applications**

When you use the Studio 4 with non-OMS MIDI applications, you must enable input devices in the Network Routing window's Input Compatibility column. See Chapter 6 for more information.

### **Sound Designer II will not communicate with some samplers**

The Studio 4 does not work with Sound Designer II and samplers (such as E-mu's

and the Prophet 2000) that communicate using non-MIDI transfer rates. To use Sound Designer II with these samplers, you must use a standard MIDI interface. Either:

- 1. Connect a standard MIDI interface to an unused Macintosh serial port, or
- 2. Connect a standard MIDI interface to one of the Studio 4's THRU ports, then use the front panel THRU switch whenever you need to send data between Sound Designer II and a non-standard sampler.

#### **Incorrect system exclusive data sent to Virtual Instruments**

You can't send system exclusive data to a virtual instrument consisting of two or more MIDI channels from the same device, or the sysex data will be sent incorrectly (If you think about the situation, you wouldn't want to do this, anyway).

#### **Difficulty receiving large system exclusive data dumps**

Reduce the Studio 4->Macintosh communication speed if you're having difficulty receiving large System Exclusive data dumps. Reduce the speed in small increments until the data is received properly.

This problem is unlikely to occur unless you have disabled the reporting of overrun errors since lost data is reported as an overrun error.

---

## **MISCELLANEOUS PROBLEMS**

### **Macintosh crashes when running the Installer**

If you experience a crash when running the installer and are using the Virex INIT for virus protection, open the Control Panel and select Virex's panel. From the pop-up menu, select **File Diagnosing Options**. Deselect **Diagnose Files when Opened** and **Check for HyperCard Virus**. Run the Installer again, and the Macintosh should not crash. If problems persist, completely remove any Virus checking INITs from your System folder (Extensions folder for System 7), restart your Macintosh, and run the Installer again.

---

## APPENDIX B: Networking a Studio 4 with a Standard MIDI Interface

You may network a Studio 4 with a standard MIDI interface. If you own an old standard MIDI interface and have more than 8 MIDI devices, the standard MIDI interface will provide a few additional MIDI ports.

A network consisting of a Studio 4 and a standard MIDI interface presents two major compromises:

- The Studio 4 must operate at 1MHz.
- You cannot use the MIDI Routing, Channelizing and Muting window to route MIDI data to devices connected to the standard MIDI interface. You can access these devices only by using OMS patches or an OMS-compatible MIDI sequencer.

Because of these limitations, you should use this network only as a temporary “band aid”. If you often need to access more than 8 MIDI devices, you should seriously consider purchasing an additional Studio 4.

**NOTE:** *You cannot network a self-powered standard interface (such as a MIDI Translator) with the Studio 4.*

If you use a dual port standard MIDI interface, you can connect its second serial port to the free Macintosh serial port to access even more MIDI ports.

If your dual port standard MIDI interface is a Studio 3, Opcode strongly recommends that you connect the Studio 3 modem port to the Studio 4 “B” port, and the Studio 3 printer port directly to the Macintosh (as shown in Figure B-4 and discussed in “Networking a Studio 4 and a Studio 3, later in this appendix). This is because the Studio 3 communicates with the Macintosh only over its printer port.

---

### COMPUTER AND MIDI CONNECTIONS

The following sections illustrate how to connect a Studio 4 to a standard MIDI interface.

- Turn off the Studio 4.
- Connect your Macintosh to the Studio 4’s “A” port.
- Connect your Studio 4’s “B” port to the standard MIDI interface.
- Connect the desired MIDI devices.

The following figure shows a typical network involving a Studio 4 and a standard MIDI interface.

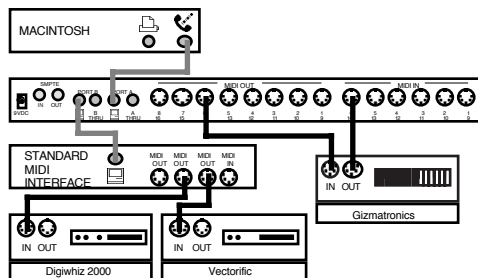

- ① Put the Studio 4's 1MHZ/Fast switch in the 1MHz position.
- ② Put the Studio 4's two MIDI/Thru switches in the MIDI position.
- ③ Turn on the Studio 4.

## SOFTWARE SETUP

- ① Create a new, custom Studio Setup document.
- ② Double-click the Studio 4 icon and make sure the Studio 4 speed is set to 1MHz.
- ③ Define and connect MIDI devices to the Studio 4.

Notice that since the standard MIDI interface isn't connected directly to the Macintosh, it doesn't appear in the Studio Setup document. In the Studio Setup document, use Studio 4 port 17 to represent the standard MIDI interface. Connect any devices attached to the standard interface to port 17 in your Studio Setup document.

The following figure shows the Studio Setup document for the studio connections depicted above.

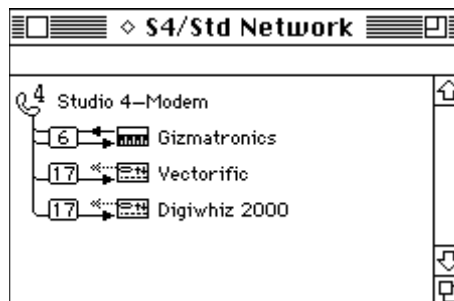

## USING THE NETWORK

You cannot access port 17 (or its devices) with the MIDI Routing, Channelizing and Muting window. You can, however, use either OMS patches or your OMS-compatible MIDI sequencer to communicate with devices connected to the standard MIDI interface.

For example, look at the following patch document.

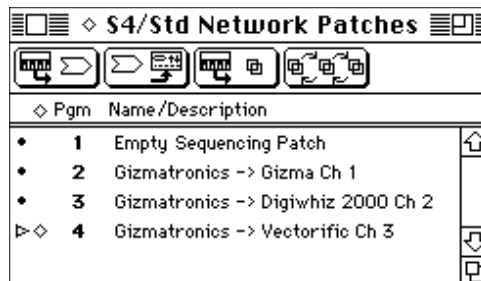

All devices (including those connected to the standard interface) appear in the patch edit window's pop-up menus.

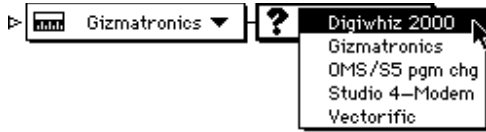

If you use OMS patches, you can access devices connected to the standard interface just as if they were connected directly to the Studio 4.



## NETWORKING A STUDIO 4 AND A STUDIO 3

If you're networking a Studio 4 and a Studio 3, read the first part of this appendix.

You can connect your Studio 3's Modem port to the Studio 4's "B" port and achieve the results discussed in the first part of this appendix. You may, however, gain additional control by connecting the Studio 3 Printer port back to the free Macintosh serial port as shown here.

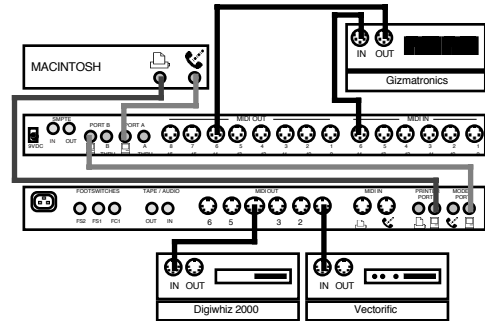

When you create a new Studio Setup document, you'll see one icon for the Studio 4 and another for the Studio 3's Printer port. The Studio 3's modem port is represented by Studio 4 cable 17.

The illustration below shows the Studio Setup document for the studio connections shown above (assuming that Studio 3 MIDI outputs are configured in their default mode—that is, outputs 1-3 assigned to the Modem and outputs 4-6 assigned to the Printer).

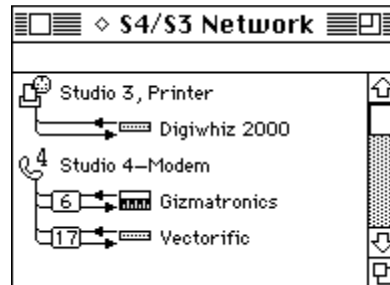

The biggest advantage of connecting the Studio 3's Printer port back to the Macintosh is that you can configure the Studio 3's six outputs to use the Modem

port and use the Studio 3's printer port for timecode communications.

---

## APPENDIX C: Specifications

---

### GENERAL

<b>Processor</b>	65C02 @ 5MHz
<b>Internal Memory</b>	32k x 8 battery backed-up SRAM
<b>External Power Supply</b>	Input: 120VAC; Output: 9VDC @ 1.5A, Center Positive -or- Input: 240VAC; Output: 9VDC @ 2A, Center Positive
<b>External Dimensions (W x H x D)</b>	48.26 x 4.39 x 18.01 cm (19" x 1.73" x 7.09") 1 Rack Space (1U space)
<b>Weight</b>	1.3kg (2 lbs, 14 oz)
<b>Operating Temperature</b>	0°C to 70°C (32°F to 158°F)

---

### CONNECTORS

<b>8 MIDI Ins</b>	
<b>8 MIDI Outs (2 duplicates)</b>	
<b>1 SMPTE In</b>	Type: Stereo Phone Jack Input Impedance: 500k $\Omega$

<b>1 SMPTE Out</b>	Type: Stereo Phone Jack Output Impedance: <math><5\Omega</math>
<b>2 RS-422 Serial Computer Ports</b>	
<b>2 RS-422 Peripheral “Thru” Ports</b>	

---

**SWITCHES**

<b>2 Peripheral “Thru” switches</b>
<b>1 Communication Speed Selection switch</b>
<b>1 Network ID switch</b>
<b>1 Power on/off switch</b>

\*Specifications and appearance subject to change without notice.



---

# INDEX

## Numerics

1-8/9-16 switch 8  
1MHz/Fast switch 7

## B

Beat clock routing 49

## C

Channelizing 44  
Communication speed  
    optimizing 31  
    setting 30  
Communication speed switch 7  
Computer connections 11  
Computer ports 9  
Connecting  
    computer 11  
    MIDI 17  
    networks 13  
    one Mac port 11  
    power 11  
    SMPTE 16  
    two Mac ports 12  
    two Macintoshes 12

## D

Direct Time Lock  
    definition 6  
Display ROM Version command 32  
Do nothing state 54  
Drum machines  
    syncing with hardware sequencers 51  
    using as sync destination 50  
    using as sync source 50

## F

Full Messages (Msgs) 58

## I

Icons  
    Studio 4 22  
Installing  
    software 19  
    Studio 4 software 19  
Installing the Studio 4 11  
Interface cables 10  
Interfaces command 21  
Interfaces dialog box 20

## J

Jam Sync 63  
JamStripe™ 64

## M

Manual  
    how to read 3  
MIDI beat clock routing 49  
MIDI channelizing 44  
MIDI In jacks 9  
MIDI In LEDs 7  
MIDI muting 42  
MIDI Out jacks 9  
MIDI Out LEDs 7  
MIDI Ports  
    front 7  
    rear 9  
MIDI routing 45  
    potential problems 47  
MIDI routing methods 29  
MIDI synchronization format 58, 63  
MIDI Time Code  
    definition 6  
MIDI Time Piece  
    networking with Studio 4 15  
    Studio Setup icons 25

- using with Studio 4 menu 32

Multiple Computers option 13

Muting 42

## **N**

Network Routing window 33–37

- MIDI In Compat column 35
- MIDI In Port column 35
- MIDI Out Compat column 36
- MIDI Out Port column 36
- overview 33
- storing in Studio 4 34
- timecode 35
- when to use 33
- with multiple Studio 4's 34

Networking

- four Studio 4's 15
- SMPTE Reader 59
- standard interface & Studio 4 16, 75–77
- Stripe SMPTE command 64
- Studio 3 & Studio 4 16, 75–78
- Studio 4 menu 32
- Studio 4's and MTP's 15
- three Studio 4's 14
- two Studio 4's 13

Networking Studio 4's 13

New Studio Setup dialog box 20

## **O**

Opening

- Studio 4 states 54

Overrun messages

- correcting 31, 71

## **P**

Packing list 4

Port A 9

Port B 9

Power connection 11

Power connector 8

Power Indicator 8

Power Switch 8

## **R**

Routing MIDI beat clock 49

Routing MIDI data 45

Routing timecode 48

Routing, Channelizing and Muting window 39–52

- channelizing 44
- clearing 52
- muting 42
- overview 40
- routing 45
- storing in Studio 4 40
- timecode routing 48
- when to use 39
- with one Studio 4 40
- with two networks 41
- with two Studio 4's in a network 41

## **S**

Saving

- Studio 4 states 53

SMPTE

- connecting to Studio 4 16
- definition 5
- displaying rate 57
- displaying timecode 57
- frame rates 5
- jam sync 63
- JamStripe™ 64
- LTC and VITC 5
- reader window 57
- reading w/networks 59
- setting frame rate 62
- setting levels 63
- setting MIDI format 58, 63
- start time 61
- stop check box 61
- stop time 61
- stripe window 61

- striping tutorial 65
  - striping w/networks 64
  - syncing tutorial 66
  - user bits 57, 64
    - with Vision 67
  - SMPTE In jack 9
  - SMPTE Indicator 8
  - SMPTE Out jack 9
  - SMPTE Reader command 57
  - SMPTE Reader window 57
  - SMPTE Reader with networks 59
  - Standard interface
    - networking with Studio 4 16, 75–77
  - State
    - definition 53
    - do nothing state 54
    - opening 54
    - saving 53
  - Stripe SMPTE command 61
  - Stripe SMPTE window 61
  - Stripe SMPTE with networks 64
  - Studio Setup document
    - creating 20
    - Studio 4 icons 22
    - updating 21
  - Studio 3
    - networking with Studio 4 16, 75–78
  - Studio 4
    - definition 3
    - front panel 7
    - icons 22
    - installing 11
    - multiple 32
    - packing list 4
    - rear panel 8
  - Studio 4 menu 31
    - Display ROM Version command 32
    - Jam Sync option 63
    - MIDI Routing, Channelizing and Muting command 39
    - Multiple Computers option 13
    - Network Routing command 33
    - Open command 54
    - Save As command 54
    - Save command 53
    - SMPTE Reader command 57
    - Stripe SMPTE command 61
      - with networks 32
  - Studio 4 state
    - definition 53
    - do nothing state 54
    - opening 54
    - saving 53
  - Switch
    - 1-8/9-16 8
    - 1MHz/Fast 7
    - power 8
    - thru (A & B) 8
- T**
- Technical support 4
  - Thru ports 9
  - Thru switches 8
  - Timecode
    - displaying 57
    - Network Routing window 35
  - Timecode routing 48
- U**
- Update Setup dialog box 21
  - User bits 64
    - displaying 57
- V**
- Vision
    - using with SMPTE 67