

# PATCH PANEL “Easy Patch”

96 Bantam (TT) Jacks

*IDC termination*

*NPPA-TT-IDC*

## INSTRUCTION MANUAL



## Index

- 1. Electrical configuration.....3
- 2. Grounding variations .....4
- 3. Wiring .....5
- 4. Cable retention .....6
- 5. Channel identification .....7
- 6. Replacement .....9
- 7. Technical data.....10
- 8. Content of supply .....11

Dimensional Drawings "Easy Patch" NPPA-TT-IDC

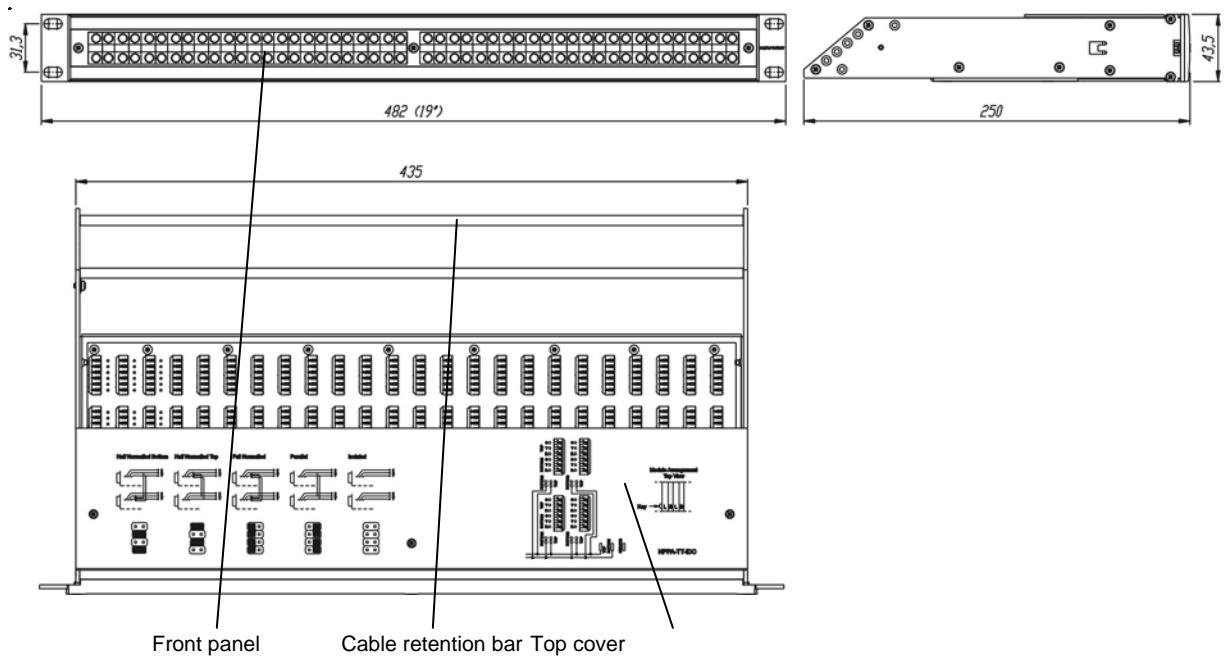

## 1. Electrical configuration

The **NEUTRIK® "Easy Patch"** is equipped with high quality, long life **NEUTRIK® NJ3TTA** double contact jacks (2 x 48) with drastically improved contact integrity. The **NEUTRIK® NJ3TTA** double contact jacks are gold plated and prewired. The **NEUTRIK® "Easy Patch"** is an innovative and compact patching system (just 1 U high) for 19" rack mounting. Robustly housed in black coated steel casing and featuring precision aluminum fittings it is built to last. The **NEUTRIK® "Easy Patch"** is suitable for analog and digital audio signals.

The new generation of the **NEUTRIK® "Easy Patch"** is easily programmable for any out of five electrical configurations (*half normalised bottom row, half normalised top row, full normalised, parallel, isolated*). The programming feature allows to set all possible switching configurations very easy with jumpers on the print and individually for each channel.

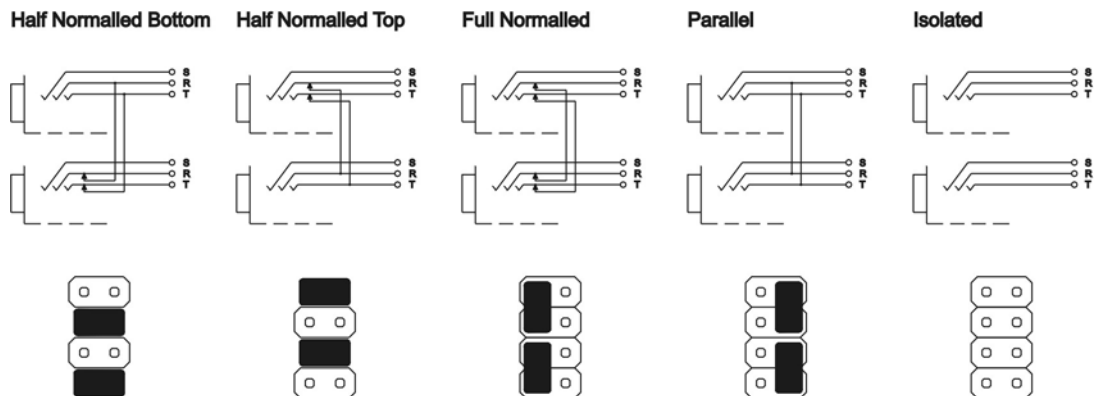

Configuration Chart

The standard configuration of the **"Easy Patch" NPPA-TT-IDC** is half normalised bottom row.

## 2. Grounding variations

The flexible grounding system provides the following alternatives.

- **Individual:** Each channel ground (“S” terminal) is connected to the dedicated ground conductor (drain wire) of the incoming cable shield, no connection between the solder pads. This is the standard configuration.
- **Central:** All channel grounds (individual Top and Bottom row) are connected via the Top and Bottom PCB bus by connecting the solder pads. The connection between Top and Bottom bus is made by jumpers.
- **Chassis Common:** The same as Central but with jumpers connecting the Top and Bottom row bus to the chassis flat tab which is connected to chassis via ground cable.

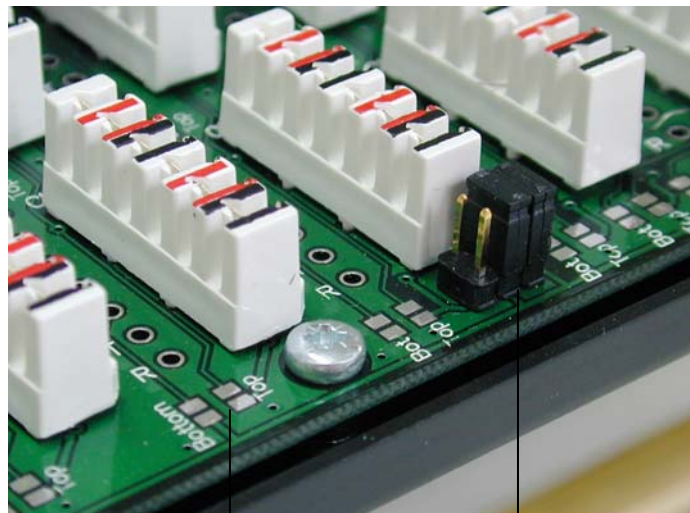
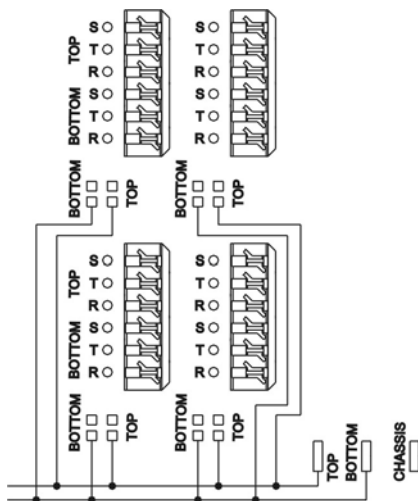

Solder Pats

Jumpers

### Symbolic of Jumper configurations

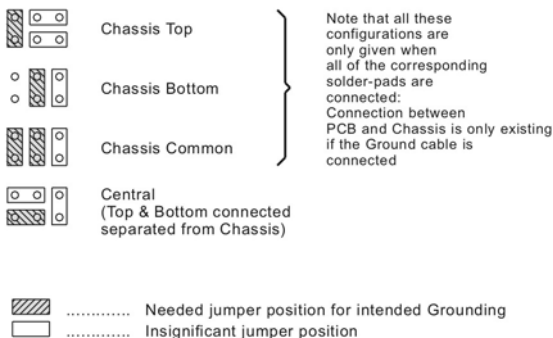

**NOTE:** In standard configuration there is no ground connection between top and bottom row unless it is provided by an inserted patch cable. If this is required, as in the case of phantom powered microphone lines, make the connection via patch cable or by the normalling feature.

### 3. Wiring

For access to the terminals remove the topcover with three cross-recessed screws (M2.5x8mm).



IDC-terminals with gas tight connection enable fast and easy wiring. No soldering or fixing with screws is necessary. For wiring please use the original LSA-tool from Krone (Produkt Nr.: 6417/1/810).



Krone LSA - tool

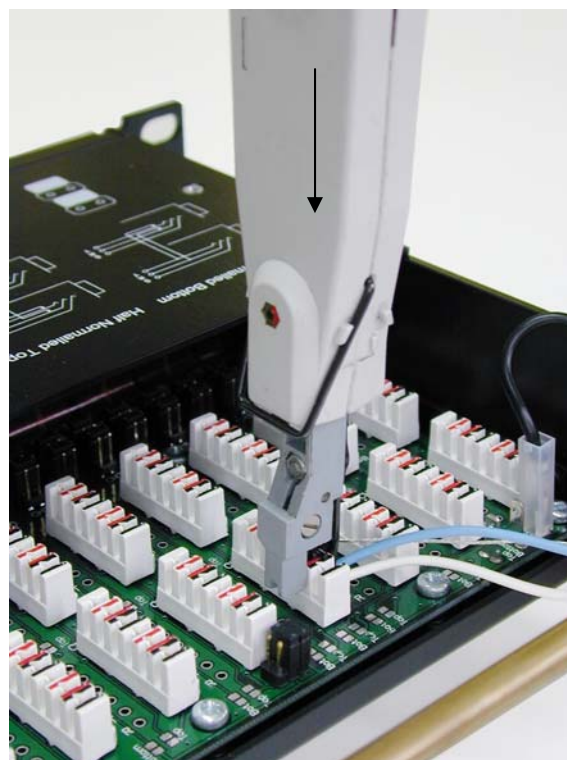

Assembly



**Color coding** of terminals:

white	-	sleeve (shield)
red	-	tip (Signal +)
black	-	ring (Signal -)

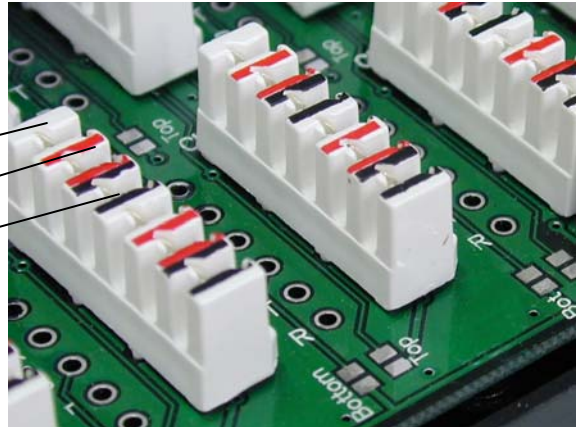

The terminal will handle solid cable AWG 26 to 20.

Wire (conductor) diameter	Wires per slot
$\geq 0.40 \text{ mm} \leq 0.65 \text{ mm}$	2
$\geq 0.65 \text{ mm} \leq 0.90 \text{ mm}$	1

When using wire in the range of 0.4 to 0.65mm diameter, the modules allow up to two identical wires of the same diameter to be terminated in one contact. It is not possible to use 2 wires of differing diameter.

**Terminations with stranded wire range**

No of strands	Dia. of each wire strand	Nominal insulated diameter
7	0.15 mm (AWG 34)	1.10 mm
7	0.20 mm (AWG 32)	1.20 mm

**4. Cable retention**

The built in cable retention bar is at the back at the casing. Simply attach the cables with cable ties to the bar as shown on the photo.

For large and heavy bundles there is an additional strain relief bar NPPA-S available. It is attached to the casing with four screw.

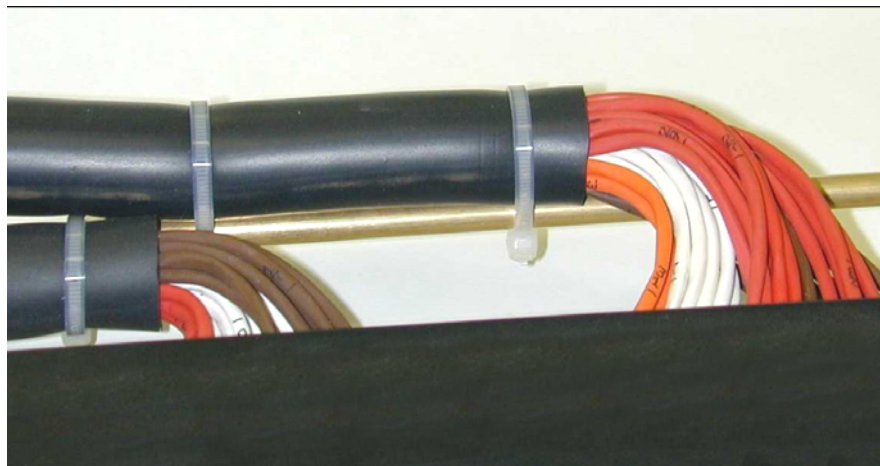

## 5. Channel identification

The front panel is equipped with **channel identification strips** located in the center of the channels and marked with the channel numbers 1-24 and 25-48 respectively.

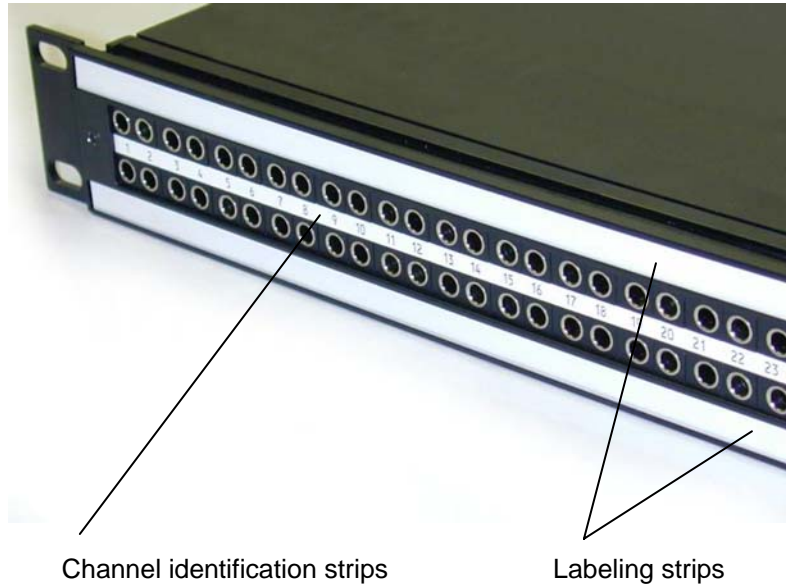

For the perfect management of the system and for individual identification according to customer's needs there are two large and separate **labeling strips**, one for the bottom and one for the top row.

- To write on the paper you have to unscrew one of the outer fixing screws of the front panel. Then pull out the side-stop, the transparent foil and the paper strip itself. After marking is done assemble the parts in reversed sequence.

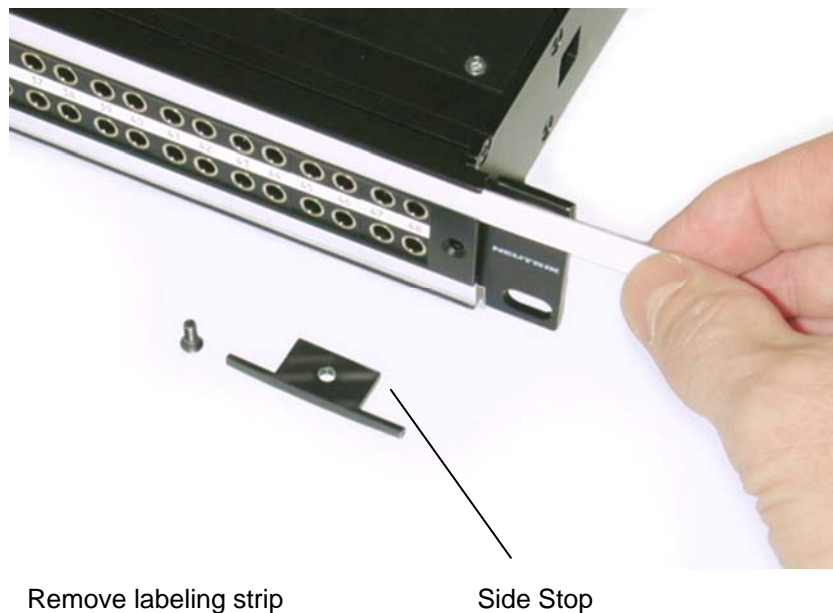

Remove labeling strip

Side Stop

**NOTE:** For easy and perfect marking you can use our designation software **“PatchLabel”** which is available on our web site [www.neutrik.com](http://www.neutrik.com) free of charge.

Print-Out software “Patch Label”

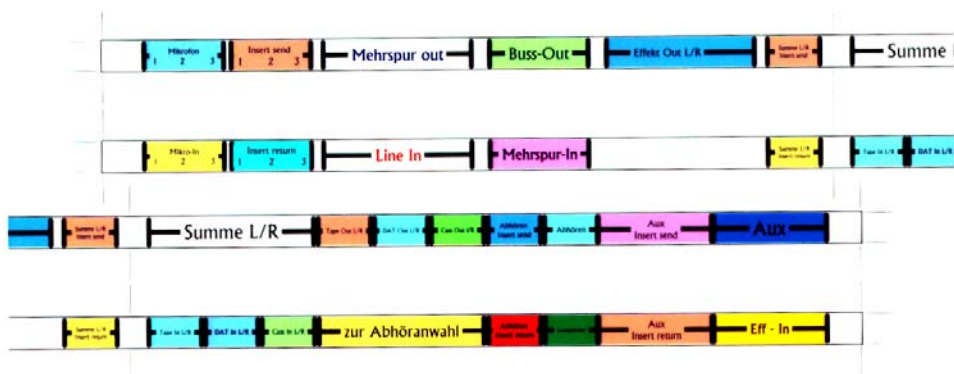



## 6. Replacement

Each individual jack pair or "**Plug-in Unit**" can be exchanged without fuss even while the unit is "on air".

For replacement just remove the easy accessible module consisting of two "**Plug-in Units**".

- First remove the front panel ❶ by unscrewing the 3 black cross-recessed screws (M3x8 *Taptite*), remove the two side-stops, ❷ push out the channel identification strips and ❸ simply pull one module with two "**Plug-in Units**" out of the casing using the supplied **disassembling pliers**. Alternatively the "**Plug-in Units**" may be pulled out by the use of two Bantam plugs (diagonally plugged in).



❶ Remove Front Panel



❷ Pull out channel ID strip



❸ Pull out module Disassembling pliers

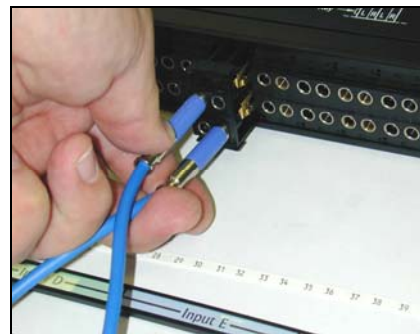

Alternative way to pull out module

- To complete, push the new two "**Plug-in Units**" into the casing again with the mark on the left side (If more than one module is removed always assemble from the center to the right or left side and be careful that the keys on the left side of the "**Plug-in Units**" find their guiding slots. If all "**Plug-in Units**" are removed start at the casing support in the center and assemble to the right and left side). Slide in again the channel identification strips (best from the outside inwards) and fix the front panel again with the black cross-recessed screws. Don't forget to insert the side-stops before fixing the screws.

## 7. Technical data

### 7.1 Electrical

<b>Frequency range:</b>	DC > 50 MHz
<b>Digital suitability:</b>	Digital audio acc. to AES/EBU
<b>Channel separation:</b>	> 100 dB @ 10 kHz, 600 $\Omega$ terminated > 40 dB @ 6 MHz, 110 $\Omega$ terminated
<b>Insulation resistance:</b>	> 10 <sup>9</sup> $\Omega$ @ 500 V dc
<b>Connector contact resistance:</b>	< 20 m $\Omega$
<b>Switch contact resistance:</b>	< 25 m $\Omega$
<b>Dielectric strength:</b>	1000 V dc

### 7.2 Mechanical

<b>Lifetime:</b>	> 5.000 Insertion / withdrawal cycles
<b>Insertion / Withdrawal force:</b>	< 10 N / > 8 N
<b>Cable retention force:</b>	70 N max per cable retention bar
<b>Dimensions (rack mount):</b>	482 mm (W) $\times$ 44 mm (H) (19" $\times$ 1 U)
<b>Depth:</b>	250 mm (9.85")
<b>Weight:</b>	2.6 kg
<b>Temperature range:</b>	-30°C to +80°C

### 7.3 Materials

<b>Jack housing:</b>	PA 66 blend
<b>Jack contacts:</b>	CuSn6 – TRIBOR® plated (0.2 $\mu$ m AuCo over 2 $\mu$ m NiP)
<b>Casing:</b>	Steel and aluminum, black coated
<b>Front Panel:</b>	AlMgSi 0.5 F22

## 8. Content of supply

### 8.1 Standard supply

The compact **NEUTRIK® "Easy Patch" NPPA-TT-IDC** consists of:

- Black coated **steel casing** with aluminum fittings
- **2 x 48** highly integrated **NEUTRIK® NJ3TTA** jacks with gold plated double contacts and specially designed normalling mechanism (standard: half normalled bottom row)
- **Integrated internal pre-wiring** with jumpers on print
- **48 KRONE IDC terminals 6-pole**
- **Chassis integrated cable retention**
- **1 Disassembling pliers**
- **1 Instruction Manual**

### 8.2 Replacement

- **NJ3TTA-4-I** blocks of **2** channels; **isolated**; cover identification color: **orange**
- **NKTT0x** **Patch cable** ( available in different lengths and colors)