

SPECTRA SONICS 110 A AMPLIFIER

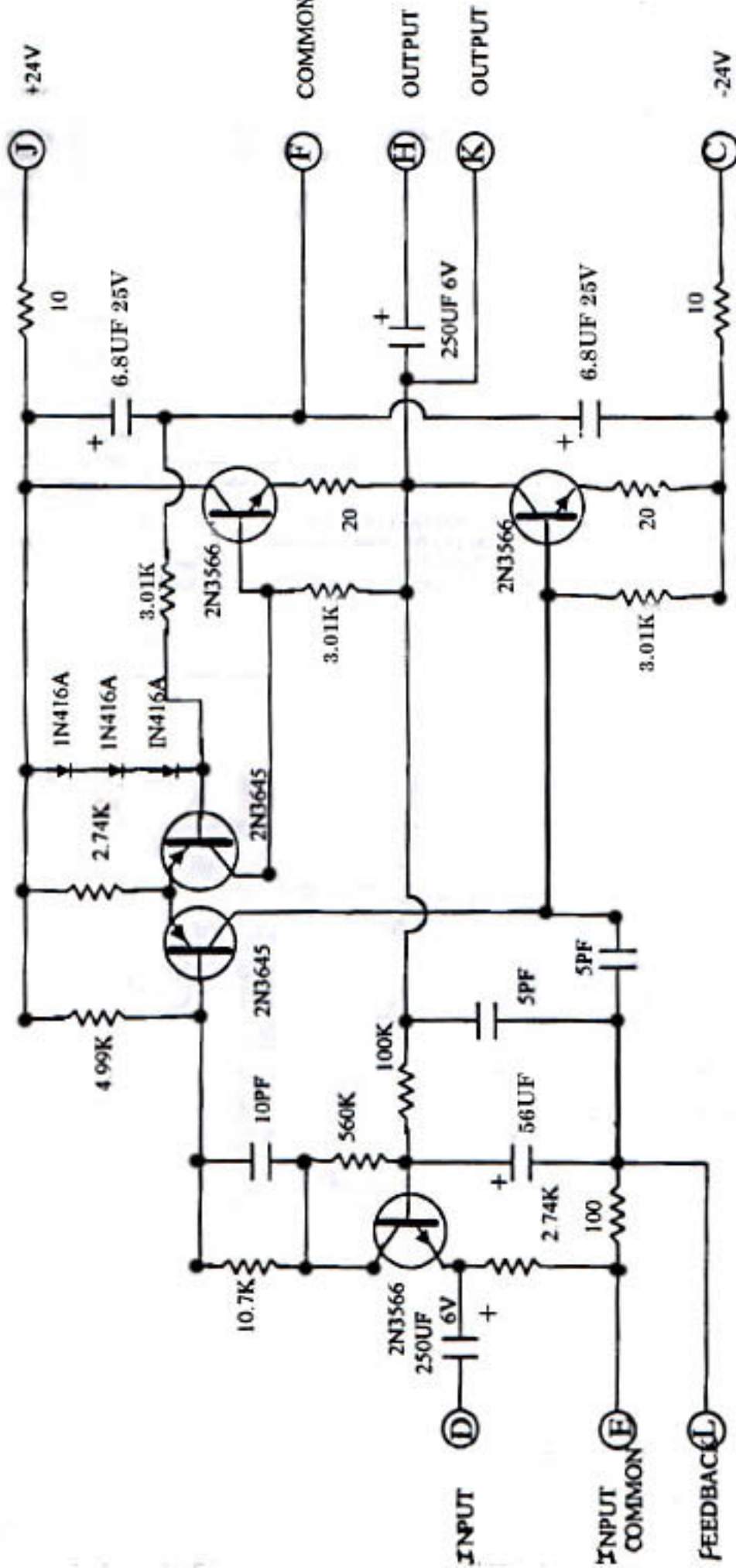

FOR GAIN OF 40 DB USE 10.7K BETWEEN H OR K AND L

FOR GAIN OF 35 DB USE 5.6K BETWEEN H OR K AND L